

08. SEK IDC Connectors

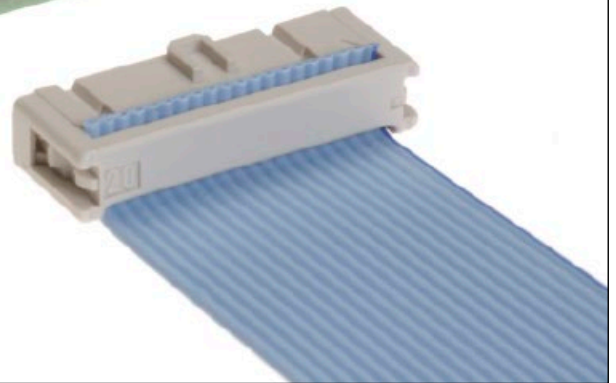
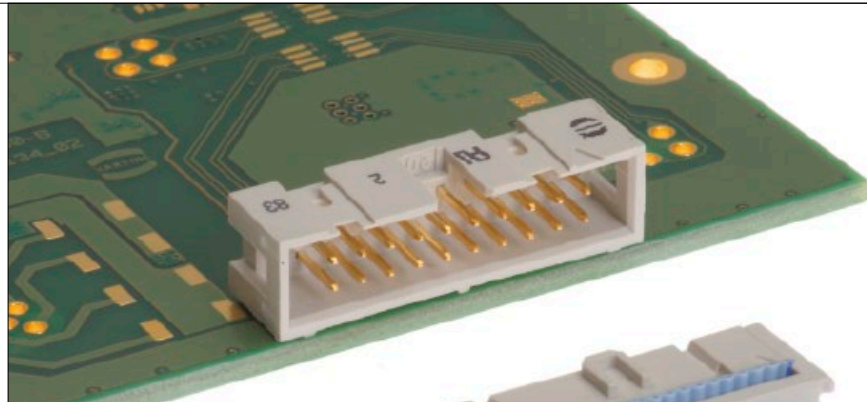

SEK connectors for flat cables enable simple and -, cost-optimized device configuration. SEK connectors are preferably used for connection within the device. HARTING offers a broad range of these cable-to-board connectors.

Assembly on the cable side takes place in one work step for all contacts via flat conductors. The SEK is an economical and reliable interface for data and signal applications in industry.

Application profile:

CONNECTION TYPE		ENVIRONMENT		APPLICATION						
Board to Board	Cable/Wire to Board	IP20	IP65 / IP67	Data	Signal	Power	high performance			
							Data transfer rate	Shielding	Number of contacts, contact density	Voltage, working current
Cable termination			PCB termination			Application standard				
Han-Quick Lock®	IDC	Crimp	THT	SMC	SMT					
Screw	Cage clamp	Axial screw	Press-in							
Separate housing		Integrated housing								

Contents

	Page
SEK connector system – introduction	08.02
General information	08.04
Solder board connectors	08.05
Male standard connectors	08.06
Male low-profile connectors	08.14
Accessories	08.16
Wrap post connectors	
Male standard connectors	08.17
Accessories	08.20
Cable connectors	
Female connectors	08.21
Pcb transition connectors, 2 rows	08.24
Pcb transition connectors, 4 rows	08.28
DIP connectors	08.30
DIN 41 612 connectors	08.32
Press-in connectors	
Male low-profile connectors	08.34
SMC solder board connectors	
Male standard SMC connectors	08.36
Male low-profile SMC connectors	08.46
Accessories	08.48
Cables and cable assemblies	08.49

IDC CONNECTOR SYSTEM [2.54 mm X 2.54 mm PITCH] FOR FLAT CABLES

HARTING's product range of flat cable connectors is designed for various cable-to-PCB applications. The HARTING SEK insulation displacement connector technology meets all requirements of the IEC 60 603-13.

HARTING assembles each SEK connector with the matching cable type according to customer specifications in order to simplify customer installation and storage.

The different types of board connectors offer 6 to 64 pins in various terminations such as solder (manual, wave or reflow) or press-in.

The cable connectors are equally suited for indoor use as well as for outdoor applications and harsh environments.

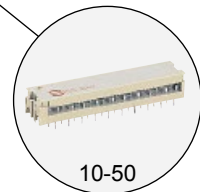
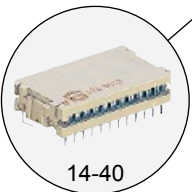
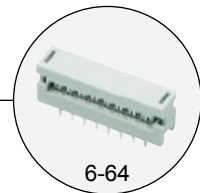
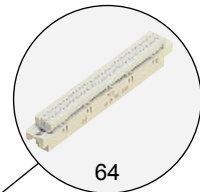
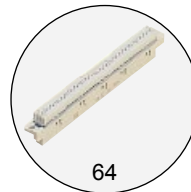
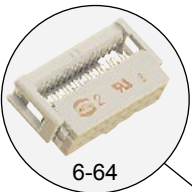

SEK

CABLE ASSEMBLIES

- HARTING can supply cable assemblies according to your specifications.
- A wide range of connector types available with various contact arrangements constitute the ideal solution to your wiring problems.
- Cables of all types in economic reel lengths are available.

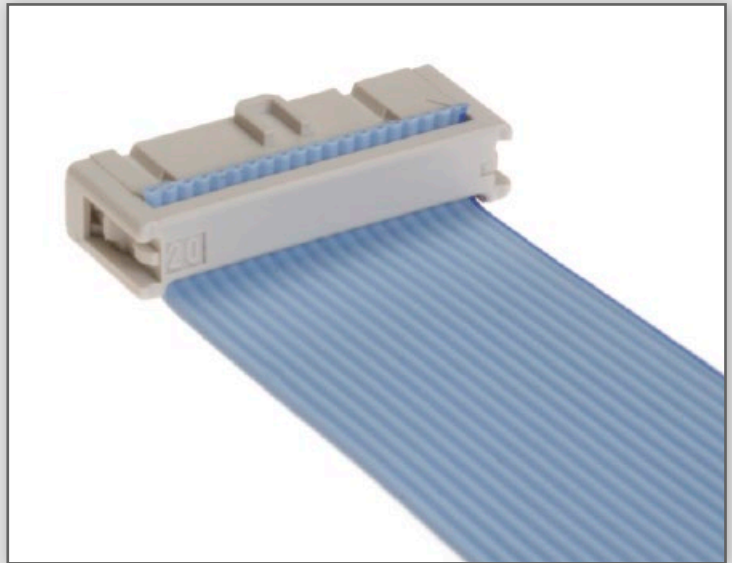

QUALITY

- Cables professionally assembled on HARTING work stations ensure reliable connections.
- Finished harnesses are subject to 100% quality checks on a HARTING test device.
- Insulation test by 1000 V.
- Contact resistance test.

SEK		General information	
Declaration of conformity			
<p>We</p> <p>HARTING KGaA</p> <p>Marlenwerder Str. 3 32339 Espelkamp</p>		<p>HARTING Electronics GmbH & Co KG</p> <p>Mainenwerder Str. 3 32339 Espelkamp</p>	
<p>Declare under our own responsibility that the</p> <p>Flat Cable Connector System</p> <p>is in conformity with the following standard</p> <p>IEC 60503-13</p> <p>Connectors for frequencies below 3MHz for use with printed board-Part 13:</p> <p>Detail specification for two-part connectors with assessed quality, for printed boards, for basic grid of 2,54 mm (0,1in) with free connectors for non-accessible insulation displacement termination (ID)</p> <p>This declaration of conformity refers to the series:</p> <p>SEK</p>			
<p>Our testing laboratory is accredited and monitored by the German Accreditation Body Technology (DA-Tech)</p> <p>Reg.-Nr. DAT-P-041/94-02</p>		<p>Our quality system is certified and monitored by DQS in conformity with the standard DIN EN ISO 9001:2000.</p> <p>Cert.-Nr. 002204 QM</p>	
<p>Espekkamp, 2004-11-18</p> <p>Place and Date of publication</p>		<p><i>Gang Spenker</i></p> <p>Senior Supervisor Senior Manager of Corporate Technology Services</p>	
<p>Espekkamp, 2004-11-18</p> <p>Place and Date of publication</p>		<p><i>H. Schell</i></p> <p>SEK-Ing. Internat. Sales and Service Center SEK-Ing. Internat. Sales and Service Center</p>	

ECONOMY

- The tested assembly of connectors and flat cables from one manufacturer guarantees a high degree of economy and reliability.
- Investments for work stations and test devices are not required.
- Stocks of piece parts are reduced.



SEK

The HARTING Insulation Displacement Connector system

Economic and reliable connections

The flat cable and connector can be preassembled and used as a component with predetermined functional characteristics.

The HARTING insulation displacement contacts pierce the insulation on the flat cable to provide a durable gastight connection with the wire.

The HARTING insulation displacement technique constitutes the ideal solution to your wiring problems.

For “non standard applications” we can manufacture designs to match your requirements. Please discuss requirements with us.

HARTING SEK connectors incorporate the latest design features and provide the assurance of high quality and reliability with economy.

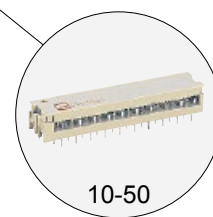
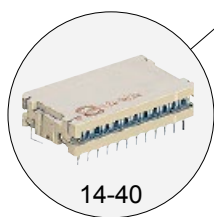
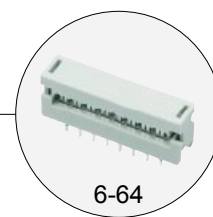
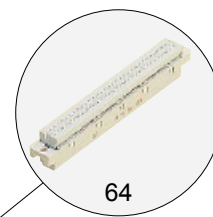
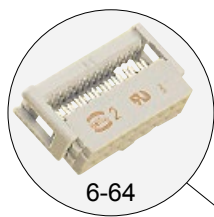

Cable assemblies

- HARTING can supply cable assemblies to customer specifications.
- A wide range of connector types available with various contact arrangements constitute the ideal solution to your wiring problems.
- Cables of all types in economic reel lengths are available.

Quality

- Cables professionally assembled on HARTING work stations ensure reliable connections.
- Finished harnesses are subject to 100% quality checks on a HARTING test device.
- Insulation test.
- Contact resistance test.

Economy

- The tested assembly of connectors and flat cables from one manufacturer guarantees a high degree of economy and reliability.
- Investment for work stations and test devices are not required.
- Stocks of piece parts are reduced.

Number of contacts 6, 10, 14, 16, 20, 24, 26, 30, 34, 40, 50, 60, 64

Contact arrangement straight, angled

Contact length 2.9 mm, 4.5 mm

Approvals IEC 60603-13
DIN EN 60603-13
D 2632
BT 224
NFC 93-428 (HE 10)
UL recognized: E102079



Pitch 2.54 mm [0.100"]

Working current 1 A

Working voltage 500 V
for pollution degree 1

Test voltage $U_{r.m.s.}$ 1 kV

Contact resistance $\leq 20 \text{ m}\Omega$
Insulation resistance $\geq 10^9 \Omega$

Temperature range -55 °C ... +125 °C
The maximum temperature includes heating of contacts and ambient temperature

Terminations For pcb hole $\varnothing 1 \pm 0.1 \text{ mm}$
DIN IEC 52 141
Diagonal: 0.79 mm

Materials Moulding Thermoplastic resin (PBT)
UL 94-V0

Contact surface Contact zone plated according to performance level¹⁾

Current carrying capacity

The current carrying capacity is limited by maximum temperature of materials for inserts and contacts including terminals. The current capacity-curve is valid for continuous, not interrupted current-loaded contacts of connectors when simultaneous power on all contacts is given, without exceeding the maximum temperature.

Control and test procedures according to DIN IEC 60512.

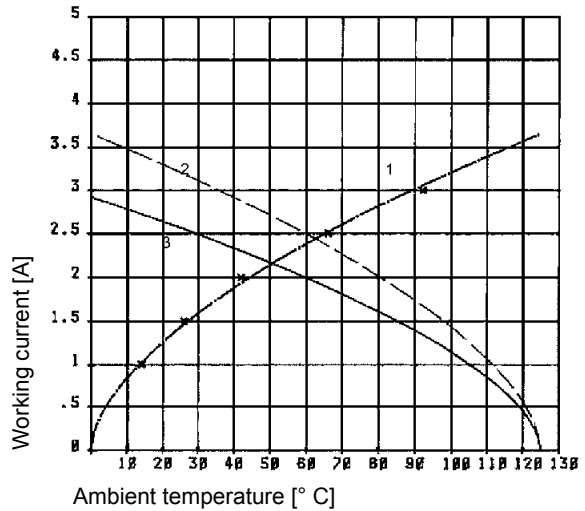

Example: 50 way connector
① Temperature rise
② Derating
③ Derating curve at $I_{max} \times 0.8$ (IEC 60512-2)

Insertion and withdrawal forces

Number of contacts	Maximum force [N]	
	Performance level 1 and 2	Performance level 3
6	12	18
10	20	30
14	28	42
16	32	48
20	40	60
24	48	72
26	52	78
30	60	90
34	68	102
40	80	120
50	100	150
60	120	180
64	128	192

¹⁾ Performance level 3 as per IEC 60603-13, ≥ 50 mating cycles, no gas test
Performance level 2 as per IEC 60603-13, ≥ 250 mating cycles, 4 days gas test
S4, plating = 0.76 μm (30 μinch) Au or PdNi equivalent

Number of contacts

6-64



Male header with angled solder pins

Identification	No. of contacts	Part number		
		Without levers	With short levers	With long levers
Male header with angled solder pins Length: 2.9 mm	6	09 18 506 □ 923	09 18 506 □ 913	09 18 506 □ 903
	10	09 18 510 □ 923	09 18 510 □ 913	09 18 510 □ 903
	14	09 18 514 □ 923	09 18 514 □ 913	09 18 514 □ 903
	16	09 18 516 □ 923	09 18 516 □ 913	09 18 516 □ 903
	20	09 18 520 □ 923	09 18 520 □ 913	09 18 520 □ 903
	24	09 18 524 □ 923	09 18 524 □ 913	09 18 524 □ 903
	26	09 18 526 □ 923	09 18 526 □ 913	09 18 526 □ 903
	30	09 18 530 □ 923	09 18 530 □ 913	09 18 530 □ 903
	34	09 18 534 □ 923	09 18 534 □ 913	09 18 534 □ 903
	40	09 18 540 □ 923	09 18 540 □ 913	09 18 540 □ 903
	50	09 18 550 □ 923	09 18 550 □ 913	09 18 550 □ 903
	60	09 18 560 □ 923	09 18 560 □ 913	09 18 560 □ 903
	64	09 18 564 □ 923	09 18 564 □ 913	09 18 564 □ 903
Kinked version on request				
Male header with angled solder pins Length: 4.5 mm	6	09 18 506 □ 921*	09 18 506 □ 911*	09 18 506 □ 901*
	10	09 18 510 □ 921*	09 18 510 □ 911*	09 18 510 □ 901*
	14	09 18 514 □ 921*	09 18 514 □ 911*	09 18 514 □ 901*
	16	09 18 516 □ 921*	09 18 516 □ 911*	09 18 516 □ 901*
	20	09 18 520 □ 921*	09 18 520 □ 911*	09 18 520 □ 901*
	24	09 18 524 □ 921*	09 18 524 □ 911*	09 18 524 □ 901*
	26	09 18 526 □ 921*	09 18 526 □ 911*	09 18 526 □ 901*
	30	09 18 530 □ 921*	09 18 530 □ 911*	09 18 530 □ 901*
	34	09 18 534 □ 921*	09 18 534 □ 911*	09 18 534 □ 901*
	40	09 18 540 □ 921*	09 18 540 □ 911*	09 18 540 □ 901*
	50	09 18 550 □ 921*	09 18 550 □ 911*	09 18 550 □ 901*
	60	09 18 560 □ 921*	09 18 560 □ 911*	09 18 560 □ 901*
	64	09 18 564 □ 921*	09 18 564 □ 911*	09 18 564 □ 901*
Kinked version on request				

SEK

08
06

* Not normally kept in stock
For accessories see page 08.16
For dimensions see page 08.07

For performance level 3 please specify digit 7*
For performance level 2 please specify digit 6*
S4 = 0.76 µm (30 µinch) Au or PdNi equivalent 5*



Number of contacts

6-64

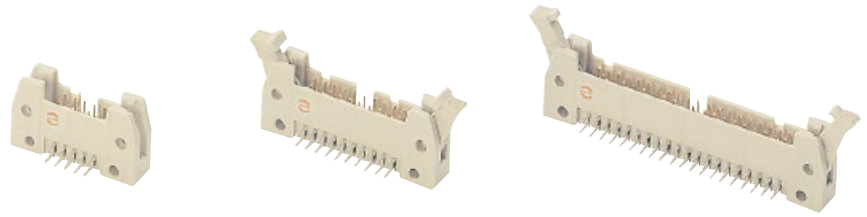

Male header with angled solder pins

Identification

Drawing

Dimensions in mm

Male header

No. of contacts	A	B	D	E	F	G
6	26.9	16.76	12.45	2.54 x 2 = 5.08	36.9	40.3
10	32.0	21.84	17.53	2.54 x 4 = 10.16	42.0	45.4
14	37.1	26.92	22.61	2.54 x 6 = 15.24	47.1	50.4
16	39.6	29.46	25.15	2.54 x 7 = 17.78	49.6	53.0
20	44.7	34.54	30.23	2.54 x 9 = 22.86	54.7	58.1
24	49.8	39.62	35.91	2.54 x 11 = 27.94	59.8	63.2
26	52.3	42.16	37.85	2.54 x 12 = 30.48	62.3	65.7
30	57.7	47.24	43.83	2.54 x 14 = 35.56	68.2	68.6
34	62.5	52.32	48.01	2.54 x 16 = 40.64	72.5	75.8
40	70.1	59.94	55.63	2.54 x 19 = 48.26	80.1	83.5
50	82.8	72.64	68.33	2.54 x 24 = 60.96	92.8	96.2
60	95.5	85.34	81.03	2.54 x 29 = 73.66	105.5	108.9
64	100.6	90.42	86.11	2.54 x 31 = 78.74	110.6	113.9

Short levers

for use with female connector without strain relief clamp

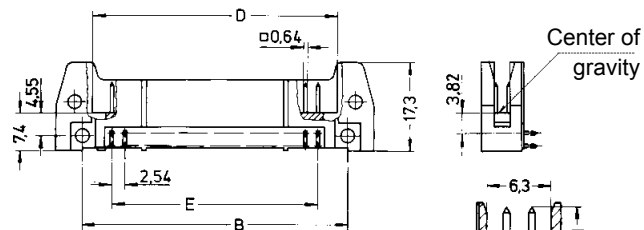

Long levers

for use with female connector with strain relief clamp

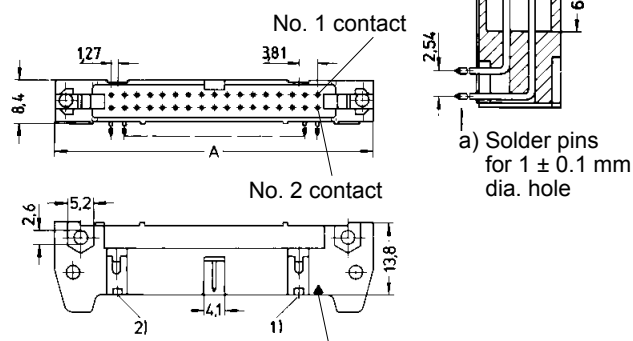

a) Solder pins for 1 ± 0.1 mm dia. hole

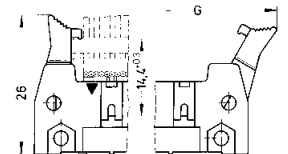

Board drillings

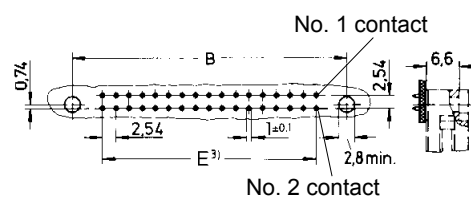

¹⁾ No polarization slot for 6, 10 or 14 way male header

²⁾ No polarization slot for 6 way male header

³⁾ Pitch tolerance: ± 0.1

Number of contacts

6-64

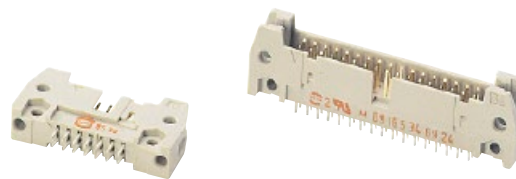

Male header with straight solder pins

Identification	No. of contacts	Part number		
		Without levers	With short levers	With long levers
Male header with straight solder pins Length: 2.9 mm	6	09 18 506 □ 924	09 18 506 □ 914	09 18 506 □ 904
	10	09 18 510 □ 924	09 18 510 □ 914	09 18 510 □ 904
	14	09 18 514 □ 924	09 18 514 □ 914	09 18 514 □ 904
	16	09 18 516 □ 924	09 18 516 □ 914	09 18 516 □ 904
	20	09 18 520 □ 924	09 18 520 □ 914	09 18 520 □ 904
	24	09 18 524 □ 924	09 18 524 □ 914	09 18 524 □ 904
	26	09 18 526 □ 924	09 18 526 □ 914	09 18 526 □ 904
	30	09 18 530 □ 924	09 18 530 □ 914	09 18 530 □ 904
	34	09 18 534 □ 924	09 18 534 □ 914	09 18 534 □ 904
	40	09 18 540 □ 924	09 18 540 □ 914	09 18 540 □ 904
	50	09 18 550 □ 924	09 18 550 □ 914	09 18 550 □ 904
	60	09 18 560 □ 924	09 18 560 □ 914	09 18 560 □ 904
	64	09 18 564 □ 924	09 18 564 □ 914	09 18 564 □ 904
	Male header with straight solder pins Length: 4.5 mm	6	09 18 506 □ 922*	09 18 506 □ 912*
10		09 18 510 □ 922*	09 18 510 □ 912*	09 18 510 □ 902*
14		09 18 514 □ 922*	09 18 514 □ 912*	09 18 514 □ 902*
16		09 18 516 □ 922*	09 18 516 □ 912*	09 18 516 □ 902*
20		09 18 520 □ 922*	09 18 520 □ 912*	09 18 520 □ 902*
24		09 18 524 □ 922*	09 18 524 □ 912*	09 18 524 □ 902*
26		09 18 526 □ 922*	09 18 526 □ 912*	09 18 526 □ 902*
30		09 18 530 □ 922*	09 18 530 □ 912*	09 18 530 □ 902*
34		09 18 534 □ 922*	09 18 534 □ 912*	09 18 534 □ 902*
40		09 18 540 □ 922*	09 18 540 □ 912*	09 18 540 □ 902*
50		09 18 550 □ 922*	09 18 550 □ 912*	09 18 550 □ 902*
60		09 18 560 □ 922*	09 18 560 □ 912*	09 18 560 □ 902*
64		09 18 564 □ 922*	09 18 564 □ 912*	09 18 564 □ 902*

SEK

08
08

Kinked version on request

* Not normally kept in stock
For accessories see page 08.16
For dimensions see page 08.09

For performance level 3 please specify digit 7*
For performance level 2 please specify digit 6*
S4 = 0.76 µm (30 µinch) Au or PdNi equivalent 5*

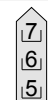

Number of contacts

6-64

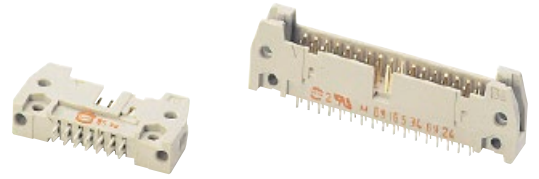

Male header with straight solder pins

Identification

Drawing

Dimensions in mm

Male header

No. of contacts	A	C	D	E	F	G
6	26.9	22.86	12.45	2.54 x 2 = 5.08	36.9	40.3
10	32.0	27.94	17.53	2.54 x 4 = 10.16	42.0	45.4
14	37.1	33.02	22.61	2.54 x 6 = 15.24	47.1	50.4
16	39.6	35.56	25.15	2.54 x 7 = 17.78	49.6	53.0
20	44.7	40.64	30.23	2.54 x 9 = 22.86	54.7	58.1
24	49.8	45.72	35.91	2.54 x 11 = 27.94	59.8	63.2
26	52.3	48.26	37.85	2.54 x 12 = 30.48	62.3	65.7
30	57.7	53.34	43.83	2.54 x 14 = 35.56	68.2	68.6
34	62.5	58.42	48.01	2.54 x 16 = 40.64	72.5	75.8
40	70.1	66.04	55.63	2.54 x 19 = 48.26	80.1	83.5
50	82.8	78.74	68.33	2.54 x 24 = 60.96	92.8	96.2
60	95.5	91.44	81.03	2.54 x 29 = 73.66	105.5	108.9
64	100.6	96.52	86.11	2.54 x 31 = 78.74	110.6	113.9

Short levers

for use with female connector without strain relief clamp

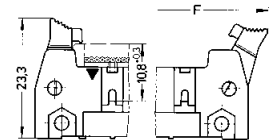
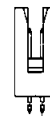
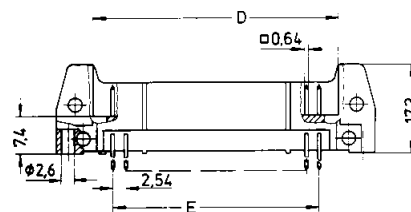

Long levers

for use with female connector with strain relief clamp

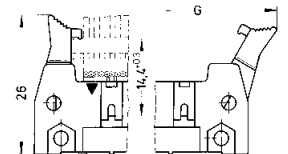
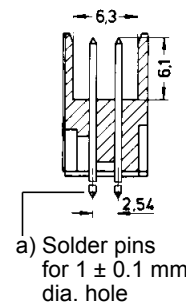
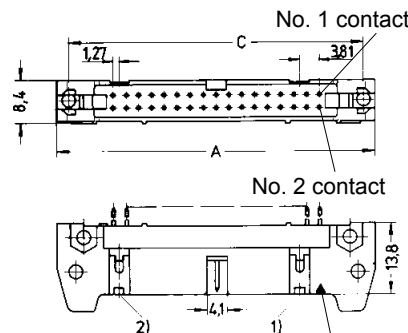

Marking No. 1 contact

No. 1 contact

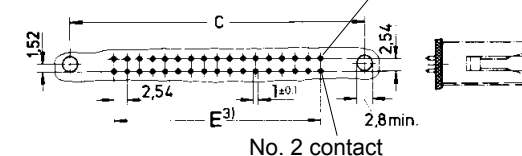

Board drillings

1) No polarization slot for 6, 10 or 14 way male header

2) No polarization slot for 6 way male header

3) Pitch tolerance: ± 0.1

Number of contacts

6-64

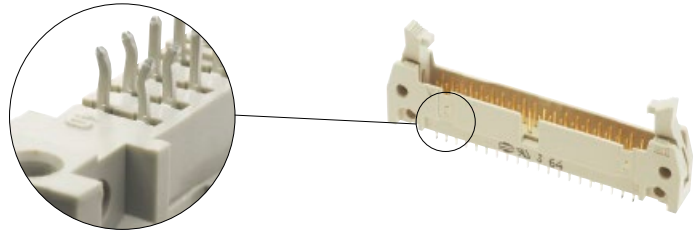

Male header with straight solder pins, kinked

Identification	No. of contacts	Part number		
		Without levers	With short levers	With long levers
Male header with straight solder pins, kinked Length: 2.9 mm				
	6	09 18 506 □ 024	09 18 506 □ 014	09 18 506 □ 004
	10	09 18 510 □ 024	09 18 510 □ 014	09 18 510 □ 004
	14	09 18 514 □ 024	09 18 514 □ 014	09 18 514 □ 004
	16	09 18 516 □ 024	09 18 516 □ 014	09 18 516 □ 004
	20	09 18 520 □ 024	09 18 520 □ 014	09 18 520 □ 004
	24	09 18 524 □ 024	09 18 524 □ 014	09 18 524 □ 004
	26	09 18 526 □ 024	09 18 526 □ 014	09 18 526 □ 004
	30	09 18 530 □ 024	09 18 530 □ 014	09 18 530 □ 004
	34	09 18 534 □ 024	09 18 534 □ 014	09 18 534 □ 004
	40	09 18 540 □ 024	09 18 540 □ 014	09 18 540 □ 004
	50	09 18 550 □ 024	09 18 550 □ 014	09 18 550 □ 004
	60	09 18 560 □ 024	09 18 560 □ 014	09 18 560 □ 004
	64	09 18 564 □ 024	09 18 564 □ 014	09 18 564 □ 004

SEK

08
10

* Not normally kept in stock
For accessories see page 08.16
For dimensions see page 08.11

For performance level 3 please specify digit 7*
For performance level 2 please specify digit 6*
S4 = 0.76 µm (30 µinch) Au or PdNi equivalent



Number of contacts

6-64

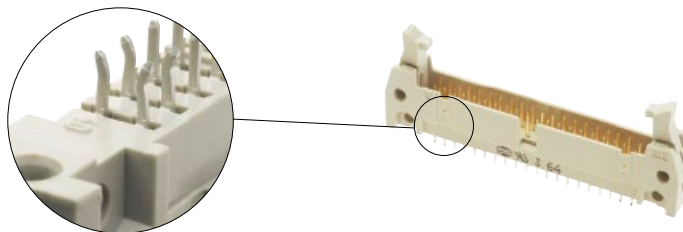

Male header with straight solder pins, kinked

Identification

Drawing

Dimensions in mm

Male header

No. of contacts	A	C	D	E	F	G
6	26.9	22.86	12.45	2.54 x 2 = 5.08	36.9	40.3
10	32.0	27.94	17.53	2.54 x 4 = 10.16	42.0	45.4
14	37.1	33.02	22.61	2.54 x 6 = 15.24	47.1	50.4
16	39.6	35.56	25.15	2.54 x 7 = 17.78	49.6	53.0
20	44.7	40.64	30.23	2.54 x 9 = 22.86	54.7	58.1
24	49.8	45.72	35.91	2.54 x 11 = 27.94	59.8	63.2
26	52.3	48.26	37.85	2.54 x 12 = 30.48	62.3	65.7
30	57.7	53.34	43.83	2.54 x 14 = 35.56	68.2	68.6
34	62.5	58.42	48.01	2.54 x 16 = 40.64	72.5	75.8
40	70.1	66.04	55.63	2.54 x 19 = 48.26	80.1	83.5
50	82.8	78.74	68.33	2.54 x 24 = 60.96	92.8	96.2
60	95.5	91.44	81.03	2.54 x 29 = 73.66	105.5	108.9
64	100.6	96.52	86.11	2.54 x 31 = 78.74	110.6	113.9

Short levers

for use with female connector without strain relief clamp

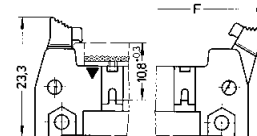
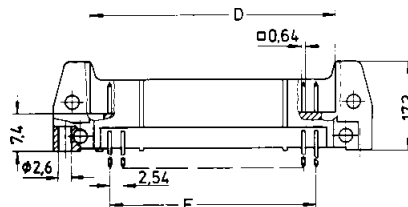

Long levers

for use with female connector with strain relief clamp

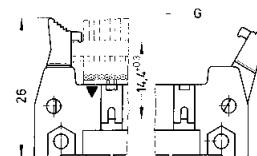
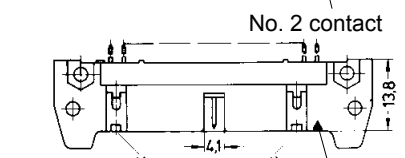
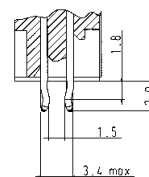
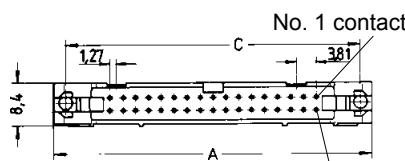

Marking No. 1 contact

No. 1 contact

Board drillings

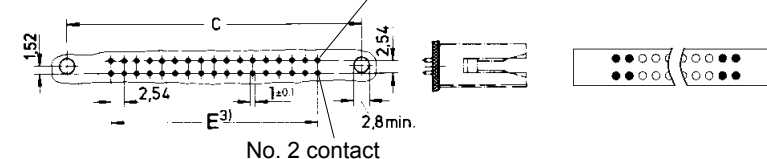

● Kinked contact: pcb thickness from 1.50 to 1.94 mm after Cu + Sn plating with non-remelted through holes \varnothing 0.80 to \varnothing 0.95 mm. Max. insertion force = 125 N. Min. retention force = 3 N.

○ Non-kinked contact: Solder pins for pcb connections \varnothing 1 ± 0.1 mm as per IEC 60603-13.

Number of contacts

6-64

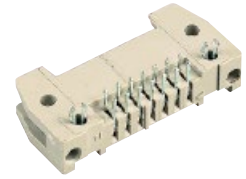

Male header with angled solder pins and board lock

Identification	No. of contacts	Part number		
		Without levers	With short levers	With long levers
<p>Male header with angled solder pins and pcb board lock</p> <p>Length: 2.9 mm for 1.6 mm pcb thickness</p> <p>To hold the connector on the pcb before the soldering process, two board locks have been added on the male header with angled solder pins.</p>	6	09 18 506 □ 973*	09 18 506 □ 963*	09 18 506 □ 953*
	10	09 18 510 □ 973*	09 18 510 □ 963*	09 18 510 □ 953*
	14	09 18 514 □ 973*	09 18 514 □ 963*	09 18 514 □ 953*
	16	09 18 516 □ 973*	09 18 516 □ 963*	09 18 516 □ 953*
	20	09 18 520 □ 973*	09 18 520 □ 963*	09 18 520 □ 953*
	24	09 18 524 □ 973*	09 18 524 □ 963*	09 18 524 □ 953*
	26	09 18 526 □ 973*	09 18 526 □ 963*	09 18 526 □ 953*
	30	09 18 530 □ 973*	09 18 530 □ 963*	09 18 530 □ 953*
	34	09 18 534 □ 973*	09 18 534 □ 963*	09 18 534 □ 953*
	40	09 18 540 □ 973*	09 18 540 □ 963*	09 18 540 □ 953*
	50	09 18 550 □ 973*	09 18 550 □ 963*	09 18 550 □ 953*
	60	09 18 560 □ 973*	09 18 560 □ 963*	09 18 560 □ 953*
	64	09 18 564 □ 973*	09 18 564 □ 963*	09 18 564 □ 953*

SEK

* Not normally kept in stock

For performance level 3 please specify digit 7
 For performance level 2 please specify digit 6
 S4 = 0.76 µm (30 µinch) Au or PdNi equivalent 5

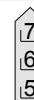
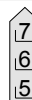

Number of contacts

6-64

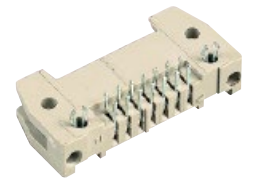

Male header with angled solder pins and board lock

Identification

Drawing

Dimensions in mm

Male header

No. of contacts	A	B	D	E	F	G
6	26.9	16.76	12.45	2.54 x 2 = 5.08	36.9	40.3
10	32.0	21.84	17.53	2.54 x 4 = 10.16	42.0	45.4
14	37.1	26.92	22.61	2.54 x 6 = 15.24	47.1	50.4
16	39.6	29.46	25.15	2.54 x 7 = 17.78	49.6	53.0
20	44.7	34.54	30.23	2.54 x 9 = 22.86	54.7	58.1
24	49.8	39.62	35.91	2.54 x 11 = 27.94	59.8	63.2
26	52.3	42.16	37.85	2.54 x 12 = 30.48	62.3	65.7
30	57.7	47.24	43.83	2.54 x 14 = 35.56	68.2	68.6
34	62.5	52.32	48.01	2.54 x 16 = 40.64	72.5	75.8
40	70.1	59.94	55.63	2.54 x 19 = 48.26	80.1	83.5
50	82.8	72.64	68.33	2.54 x 24 = 60.96	92.8	96.2
60	95.5	85.34	81.03	2.54 x 29 = 73.66	105.5	108.9
64	100.6	90.42	86.11	2.54 x 31 = 78.74	110.6	113.9

Short levers

for use with female connector without strain relief clamp

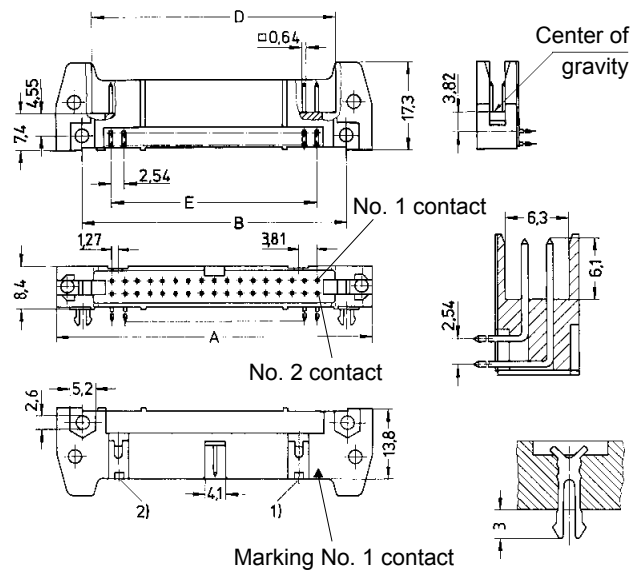

Long levers

for use with female connector with strain relief clamp

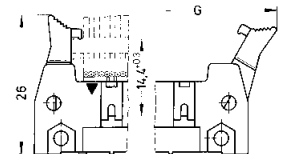

Board drillings

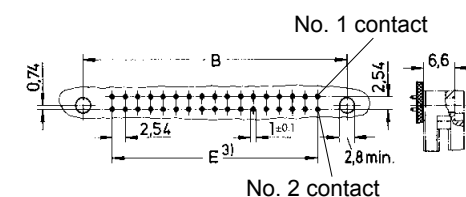

1) No polarization slot for 6, 10 or 14 way male header

2) No polarization slot for 6 way male header

3) Pitch tolerance: ± 0.1

Number of contacts

6-64

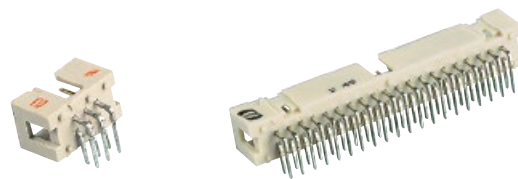

Low-profile male header, angled solder pins

Identification	No. of contacts	Part number	Drawing	Dimensions in mm
----------------	-----------------	-------------	---------	------------------

Male header with angled solder pins

Length: 2.9 mm

6	09 18 506	□ 323
10	09 18 510	□ 323
14	09 18 514	□ 323
16	09 18 516	□ 323
20	09 18 520	□ 323
26	09 18 526	□ 323
30	09 18 530	□ 323
34	09 18 534	□ 323
40	09 18 540	□ 323
50	09 18 550	□ 323
60	09 18 560	□ 323
64	09 18 564	□ 323

No. of contacts	A	B	E
6	15.2	12.78	2.54 x 2 = 5.08
10	20.3	17.86	2.54 x 4 = 10.16
14	25.4	22.94	2.54 x 6 = 15.24
16	27.9	25.48	2.54 x 7 = 17.78
20	33.0	30.56	2.54 x 9 = 22.86
26	40.6	38.18	2.54 x 12 = 30.48
30	45.72	43.26	2.54 x 14 = 35.56
34	50.8	48.34	2.54 x 16 = 40.64
40	58.4	55.96	2.54 x 19 = 48.26
50	71.3	68.66	2.54 x 24 = 60.96
60	84.0	81.36	2.54 x 29 = 73.66
64	89.1	86.44	2.54 x 31 = 78.74

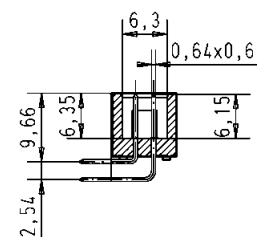

Solder pins for 1 ± 0.1 mm dia. hole

Marking No. 1 contact

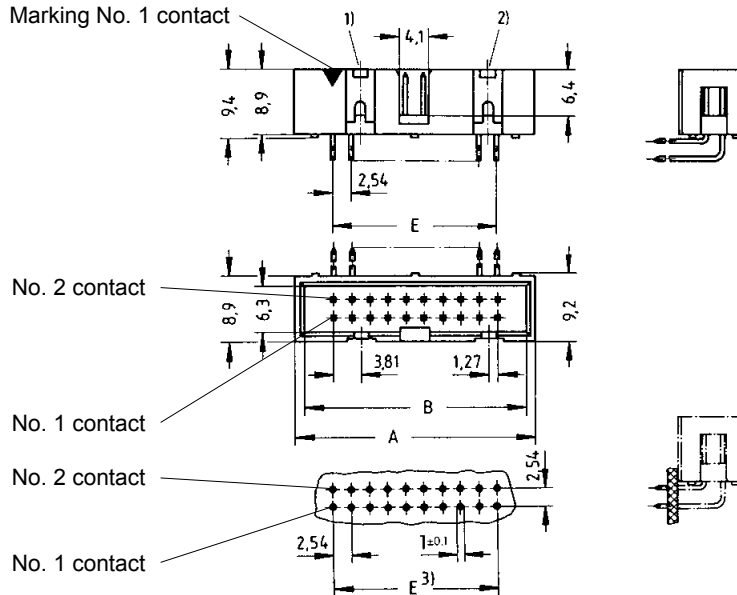

For performance level 3 please specify digit 7
 For performance level 2 please specify digit 6
 S4 = 0.76 µm (30 µinch) Au or PdNi equivalent



Identification	Part number	Drawing	Dimensions in mm
----------------	-------------	---------	------------------

Locking lever for female connector with strain relief

in conjunction with low-profile male header

When the security of latching is required and space is a premium, these locking levers can be fitted onto the strain relief of the HARTING female connector.

09 18 000 9905⁴⁾

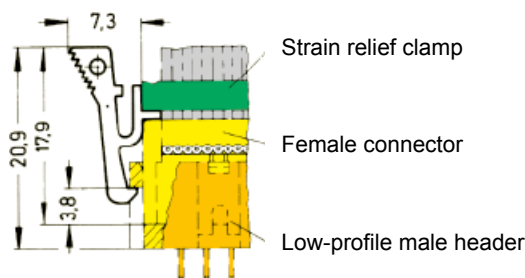

* Not normally kept in stock

¹⁾ No polarization slot for 6, 10 or 14 way male header
²⁾ No polarization slot for 6 way male header

³⁾ Pitch tolerance: ± 0.1
⁴⁾ Order 2 per female connector

Number of contacts

6-64



Low-profile male header, straight solder pins

Identification	No. of contacts	Part number	Drawing	Dimensions in mm
----------------	-----------------	-------------	---------	------------------

Male header with straight solder pins
Length: 2.9 mm

6	09 18 506	□ 324
10	09 18 510	□ 324
14	09 18 514	□ 324
16	09 18 516	□ 324
20	09 18 520	□ 324
26	09 18 526	□ 324
30	09 18 530	□ 324
34	09 18 534	□ 324
40	09 18 540	□ 324
50	09 18 550	□ 324
60	09 18 560	□ 324
64	09 18 564	□ 324

No. of contacts	A	B	E
6	15.2	12.78	2.54 x 2 = 5.08
10	20.3	17.86	2.54 x 4 = 10.16
14	25.4	22.94	2.54 x 6 = 15.24
16	27.9	25.48	2.54 x 7 = 17.78
20	33.0	30.56	2.54 x 9 = 22.86
26	40.6	38.18	2.54 x 12 = 30.48
30	45.72	43.26	2.54 x 14 = 35.56
34	50.8	48.34	2.54 x 16 = 40.64
40	58.4	55.96	2.54 x 19 = 48.26
50	71.3	68.66	2.54 x 24 = 60.96
60	84.0	81.36	2.54 x 29 = 73.66
64	89.1	86.44	2.54 x 31 = 78.74

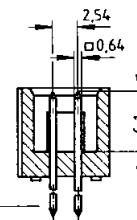

Solder pins for 1 ± 0.1 mm dia. hole

Male header with straight solder pins
Length: 4.5 mm

6	09 18 506	□ 322*
10	09 18 510	□ 322*
14	09 18 514	□ 322*
16	09 18 516	□ 322*
20	09 18 520	□ 322*
26	09 18 526	□ 322*
30	09 18 530	□ 322*
34	09 18 534	□ 322*
40	09 18 540	□ 322*
50	09 18 550	□ 322*
60	09 18 560	□ 322*
64	09 18 564	□ 322*

Marking No. 1 contact

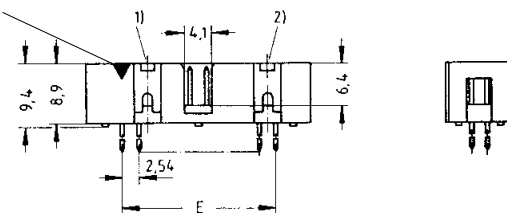

No. 2 contact

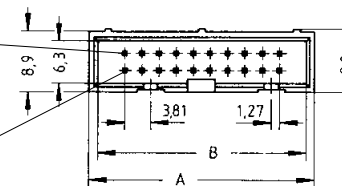

No. 1 contact

No. 2 contact

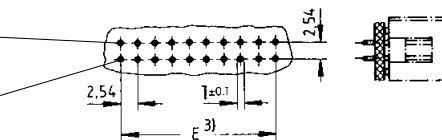

No. 1 contact

For performance level 3 please specify digit 7
For performance level 2 please specify digit 6
S4 = 0.76 µm (30 µinch) Au or PdNi equivalent



Identification	Part number	Drawing	Dimensions in mm
----------------	-------------	---------	------------------

Locking lever for female connector with strain relief
in conjunction with low-profile male header

When the security of latching is required and space is a premium, these locking levers can be fitted onto the strain relief of the HARTING female connector.

09 18 000 9905⁴⁾

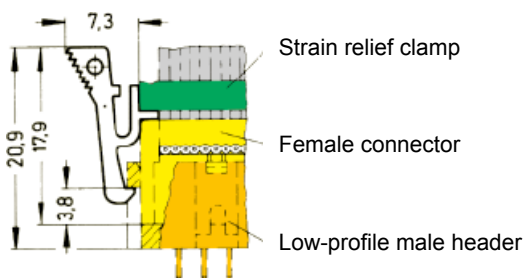

* Not normally kept in stock

¹⁾ No polarization slot for 6, 10 or 14 way male header
²⁾ No polarization slot for 6 way male header

³⁾ Pitch tolerance: ± 0.1
⁴⁾ Order 2 per female connector

Accessories

Identification	Part number	Drawing	Dimensions in mm
<p>Polarization key</p> <p>1) Part number comprises 2 keys</p>	<p>09 18 500 9902¹⁾</p>		
<p>Locking lever (snaps into place, can be fitted whenever required)</p> <p>2) Order 2 per male header</p>	<p>Long: 09 18 000 9903²⁾</p> <p>Short: 09 18 000 9904²⁾</p>	<p>Long</p> <p>Short</p> <p>For use with female connector <u>with</u> strain relief clamp</p> <p>For use with female connector <u>without</u> strain relief clamp</p>	
<p>Fixing screws for 1.6 mm P.C. board</p> <p>3) Part number comprises 50 pieces</p>	<p>09 18 000 9906³⁾</p>	<p>BZ 2.9x6.5 (DIN 7981 or DIN 7049)</p> <p>For connectors with part numbers 09 18 5xx x9xx: screwing torque 0.2 Nm 09 19 5xx x9xx: screwing torque 0.4 – 0.5 Nm</p> <p>Screw material: Steel (Inox A2)</p> <p>Plating: Nickel</p>	
<p>Coding system with loss of contact</p> <p>4) Part number comprises 6 code pins</p>	<p>Code pin 09 18 000 9901⁴⁾</p> <p>Removal tool for male contacts 09 99 000 0133</p>	<p>To avoid cross-plugging adjacent connectors a coding system is required. A code pin is inserted into the appropriate cavity in the female connector. The corresponding male contact is removed by a special removal tool.</p>	

SEK

Number of contacts	6, 10, 14, 16, 20, 24, 26, 30, 34, 40, 50, 60, 64	
Contact arrangement	straight, angled	
Contact length	15 mm	
Approvals	IEC 60603-13 DIN EN 60603-13 D 2632 BT 224 NFC 93-428 (HE 10)	
Pitch	2.54 mm [0.100"]	
Working current	1 A	
Working voltage	500 V for pollution degree 1	
Test voltage $U_{r.m.s.}$	1 kV	
Contact resistance Insulation resistance	$\leq 20 \text{ m}\Omega$ $\geq 10^9 \Omega$	
Temperature range	-55 °C ... +125 °C The maximum temperature includes heating of contacts and ambient temperature	
Terminations	0.6 mm x 0.6 mm Diagonal: 0.86 mm	
Materials Moulding	Thermoplastic resin (PBT) UL 94-V0	
Contact surface Contact zone	plated according to performance level ¹⁾	

SEK

¹⁾ Performance level 3 as per IEC 60603-13, ≥ 50 mating cycles, no gas test
Performance level 2 as per IEC 60603-13, ≥ 250 mating cycles, 4 days gas test
S4, plating = 0.76 μm (30 μinch) Au or PdNi equivalent

Number of contacts

6-64

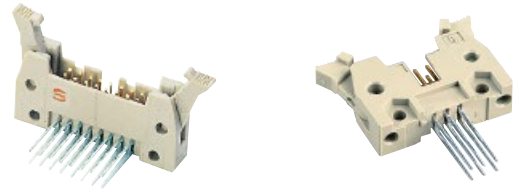

Male header with wrap posts

Identification	No. of contacts	Part number		
		Without levers	With short levers	With long levers
Male header with angled wrap posts Length: 15 mm <input type="checkbox"/> 0.6 mm	6	09 18 506 □ 926*	09 18 506 □ 916*	09 18 506 □ 906*
	10	09 18 510 □ 926*	09 18 510 □ 916*	09 18 510 □ 906*
	14	09 18 514 □ 926*	09 18 514 □ 916*	09 18 514 □ 906*
	16	09 18 516 □ 926*	09 18 516 □ 916*	09 18 516 □ 906*
	20	09 18 520 □ 926*	09 18 520 □ 916*	09 18 520 □ 906*
	24	09 18 524 □ 926*	09 18 524 □ 916*	09 18 524 □ 906*
	26	09 18 526 □ 926*	09 18 526 □ 916*	09 18 526 □ 906*
	30	09 18 530 □ 926*	09 18 530 □ 916*	09 18 530 □ 906*
	34	09 18 534 □ 926*	09 18 534 □ 916*	09 18 534 □ 906*
	40	09 18 540 □ 926*	09 18 540 □ 916*	09 18 540 □ 906*
	50	09 18 550 □ 926*	09 18 550 □ 916*	09 18 550 □ 906*
	60	09 18 560 □ 926*	09 18 560 □ 916*	09 18 560 □ 906*
	64	09 18 564 □ 926*	09 18 564 □ 916*	09 18 564 □ 906*
	Male header with straight wrap posts Length: 15 mm <input type="checkbox"/> 0.6 mm	6	09 18 506 □ 927*	09 18 506 □ 917*
10		09 18 510 □ 927*	09 18 510 □ 917*	09 18 510 □ 907*
14		09 18 514 □ 927*	09 18 514 □ 917*	09 18 514 □ 907*
16		09 18 516 □ 927*	09 18 516 □ 917*	09 18 516 □ 907*
20		09 18 520 □ 927*	09 18 520 □ 917*	09 18 520 □ 907*
24		09 18 524 □ 927*	09 18 524 □ 917*	09 18 524 □ 907*
26		09 18 526 □ 927*	09 18 526 □ 917*	09 18 526 □ 907*
30		09 18 530 □ 927*	09 18 530 □ 917*	09 18 530 □ 907*
34		09 18 534 □ 927*	09 18 534 □ 917*	09 18 534 □ 907*
40		09 18 540 □ 927*	09 18 540 □ 917*	09 18 540 □ 907*
50		09 18 550 □ 927*	09 18 550 □ 917*	09 18 550 □ 907*
60		09 18 560 □ 927*	09 18 560 □ 917*	09 18 560 □ 907*
64		09 18 564 □ 927*	09 18 564 □ 917*	09 18 564 □ 907*

SEK

* Not normally kept in stock
 For accessories see page 08.20
 For dimensions see page 08.19

For performance level 3 please specify digit 7
 For performance level 2 please specify digit 6
 S4 = 0.76 µm (30 µinch) Au or PdNi equivalent

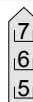

Number of contacts

6-64

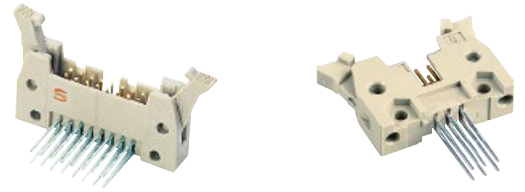

Male header with wrap posts

Identification

Drawing

Dimensions in mm

Male header

No. of contacts	A	B	C	D	E	F	G
6	26.9	16.76	22.86	12.45	2.54 x 2 = 5.08	36.9	40.3
10	32.0	21.84	27.94	17.53	2.54 x 4 = 10.16	42.0	45.4
14	37.1	26.92	33.02	22.61	2.54 x 6 = 15.24	47.1	50.4
16	39.6	29.46	35.56	25.15	2.54 x 7 = 17.78	49.6	53.0
20	44.7	34.54	40.64	30.23	2.54 x 9 = 22.86	54.7	58.1
24	49.8	39.62	45.72	35.91	2.54 x 11 = 27.94	59.8	63.2
26	52.3	42.16	48.26	37.85	2.54 x 12 = 30.48	62.3	65.7
30	57.7	47.24	53.43	43.83	2.54 x 14 = 35.56	68.2	68.6
34	62.5	52.32	58.42	48.01	2.54 x 16 = 40.64	72.5	75.8
40	70.1	59.94	66.04	55.63	2.54 x 19 = 48.26	80.1	83.5
50	82.8	72.64	78.74	68.33	2.54 x 24 = 60.96	92.8	96.2
60	95.5	85.34	91.44	81.03	2.54 x 29 = 73.66	105.5	108.9
64	100.6	90.42	96.52	86.11	2.54 x 31 = 78.74	110.6	113.9

Long levers

for use with female connector with strain relief clamp

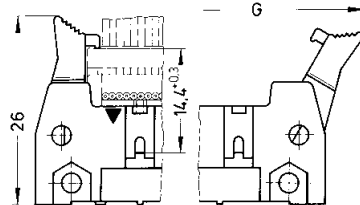

Short levers

for use with female connector without strain relief clamp

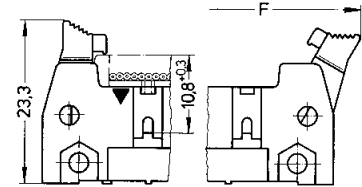

Angled versions

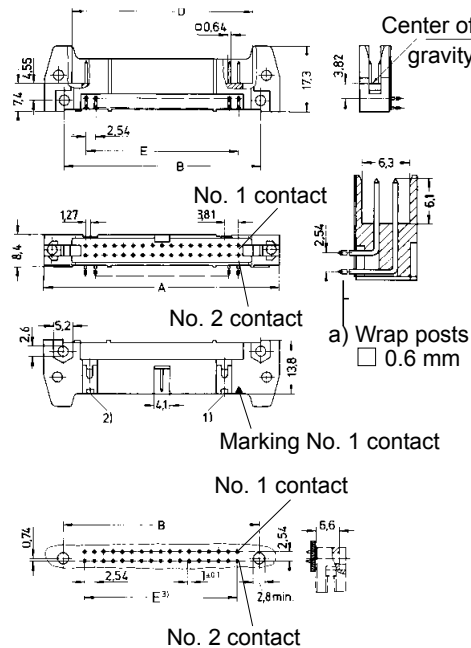

Straight versions

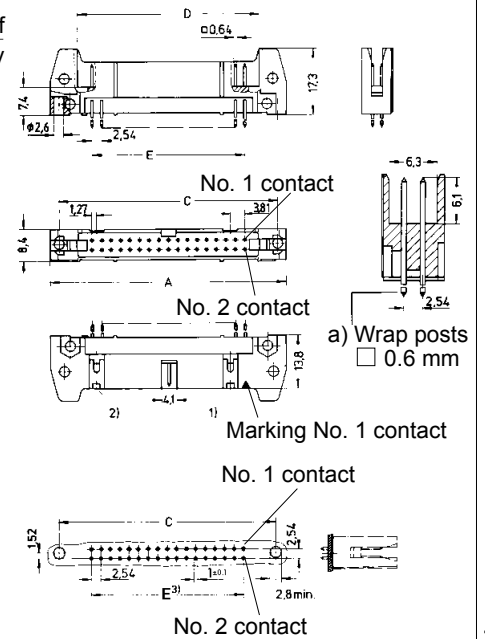

Board drillings

For accessories see page 08.20

¹⁾ No polarization slot for 6, 10 or 14 way male header

²⁾ No polarization slot for 6 way male header

³⁾ Pitch tolerance: ± 0.1

Accessories

Identification	Part number	Drawing	Dimensions in mm
<p>Polarization key</p> <p>1) Part number comprises 2 keys</p>	<p>09 18 500 9902¹⁾</p>		
<p>Locking lever (snaps into place, can be fitted whenever required)</p> <p>2) Order 2 per male header</p>	<p>Long: 09 18 000 9903²⁾</p> <p>Short: 09 18 000 9904²⁾</p>	<p>Long</p> <p>Short</p> <p>For use with female connector <u>with</u> strain relief clamp</p> <p>For use with female connector <u>without</u> strain relief clamp</p>	
<p>Fixing screws for 1.6 mm P.C. board</p> <p>3) Part number comprises 50 pieces</p>	<p>09 18 000 9906³⁾</p>	<p>BZ 2.9x6.5 (DIN 7981 or DIN 7049)</p> <p>For connectors with part numbers 09 18 5xx x9xx: screwing torque 0.2 Nm 09 19 5xx x9xx: screwing torque 0.4 – 0.5 Nm</p> <p>Screw material: Steel (Inox A2)</p> <p>Plating: Nickel</p>	
<p>Coding system with loss of contact</p> <p>4) Part number comprises 6 code pins</p>	<p>Code pin</p> <p>09 18 000 9901⁴⁾</p> <p>Removal tool for male contacts</p> <p>09 99 000 0133</p>	<p>To avoid cross-plugging adjacent connectors a coding system is required. A code pin is inserted into the appropriate cavity in the female connector. The corresponding male contact is removed by a special removal tool.</p>	

SEK



Number of contacts 6, 10, 14, 16, 20, 24, 26, 30, 34, 40, 50, 60, 64

Approvals IEC 60603-13
DIN EN 60603-13
D 2632
BT 224
NFC 93-428 (HE 10)
UL recognized: E102079



Pitch On pcb side: 2.54 mm [0.100"]
On cable side: 1.27 mm [0.050"]

Rated current 2.5 A min. at ambient temperature of 30 °C

Working voltage 320 V for pollution degree 1

Test voltage $U_{r.m.s.}$ 1 kV

Contact resistance $\leq 20 \text{ m}\Omega$
Insulation resistance $\geq 10^9 \Omega$

Temperature range -55 °C ... +125 °C
The maximum temperature includes heating of contacts and ambient temperature

Terminations IDC flat cable
1.27 mm [0.050"] pitch:
AWG 26/7 – AWG 28/7

Materials Moulding Thermoplastic resin (PBT) UL 94-V0

Contact surface Contact zone gold-plated according to performance level¹⁾

Current carrying capacity

The current carrying capacity is limited by maximum temperature of materials for inserts and contacts including terminals. The current capacity-curve is valid for continuous, not interrupted current-loaded contacts of connectors when simultaneous power on all contacts is given, without exceeding the maximum temperature.

Control and test procedures according to IEC 60512.

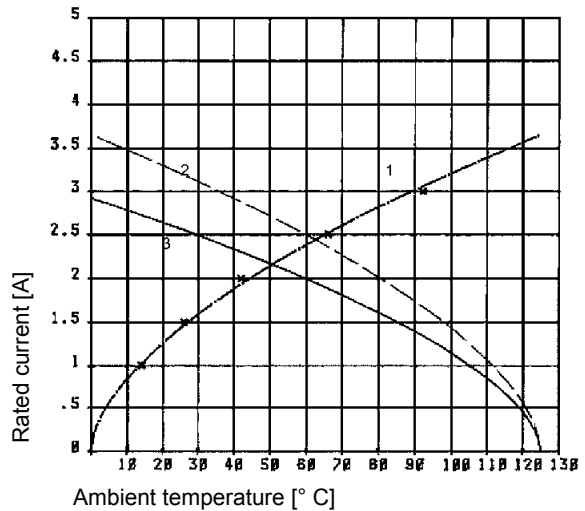

Example: 50 way connector

- ① Temperature rise
- ② Derating
- ③ Derating curve at $I_{max} \times 0.8$ (IEC 60512-2)

Insertion and withdrawal forces

Number of contacts	Maximum force [N]	
	Performance level 1 and 2	Performance level 3
6	12	18
10	20	30
14	28	42
16	32	48
20	40	60
24	48	72
26	52	78
30	60	90
34	68	102
40	80	120
50	100	150
60	120	180
64	128	192



¹⁾ Performance level 3 as per IEC 60603-13, ≥ 50 mating cycles, no gas test
Performance level 2 as per IEC 60603-13, ≥ 250 mating cycles, 4 days gas test
S4, plating = 0.76 μm (30 μinch) Au or PdNi equivalent

Number of contacts

6-64

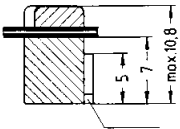
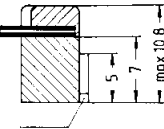
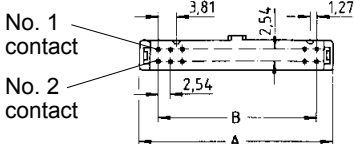
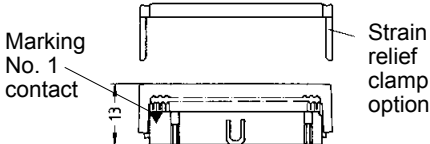

Female connector

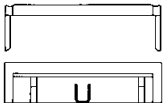
Identification	No. of contacts	Part number		Drawing	Dimensions in mm																																																																		
Female connector with central polarization without strain relief clamp 		open end cover	closed end cover	open end cover	closed end cover																																																																		
	6	09 18 506 □ 803	09 18 506 □ 804																																																																				
	10	09 18 510 □ 803	09 18 510 □ 804	option																																																																			
	14	09 18 514 □ 803	09 18 514 □ 804																																																																				
	16	09 18 516 □ 803	09 18 516 □ 804																																																																				
	20	09 18 520 □ 803	09 18 520 □ 804																																																																				
	24	09 18 524 □ 803	09 18 524 □ 804																																																																				
	26	09 18 526 □ 803	09 18 526 □ 804																																																																				
	30	09 18 530 □ 803	09 18 530 □ 804																																																																				
	34	09 18 534 □ 803	09 18 534 □ 804																																																																				
	40	09 18 540 □ 803	09 18 540 □ 804																																																																				
	50	09 18 550 □ 803	09 18 550 □ 804																																																																				
	60	09 18 560 □ 803	09 18 560 □ 804																																																																				
	64	09 18 564 □ 803	09 18 564 □ 804																																																																				
	without strain relief clamp with bulk packaging 2) Packaging unit (PU) 5,000 pieces 3) PU 3,000 pieces	6	09 18 506 □ 803 58U ²⁾		 No. 1 contact No. 2 contact Marking No. 1 contact  Strain relief clamp option 																																																																		
		10	09 18 510 □ 803 58U ²⁾																																																																				
		14	09 18 514 □ 803 58U ²⁾																																																																				
		16	09 18 516 □ 803 58U ²⁾																																																																				
		20	09 18 520 □ 803 58U ²⁾																																																																				
		26	09 18 526 □ 803 58U ²⁾																																																																				
30		09 18 530 □ 803 58U ²⁾																																																																					
40		09 18 540 □ 803 58U ³⁾																																																																					
with strain relief clamp 	6	09 18 506 □ 813	09 18 506 □ 814*	<table border="1" style="width: 100%; border-collapse: collapse;"> <tr> <td>No. of contacts</td> <td>6</td> <td>10</td> <td>14</td> <td>16</td> <td>20</td> </tr> <tr> <td>A</td> <td>12.20</td> <td>17.30</td> <td>22.40</td> <td>24.90</td> <td>30.00</td> </tr> <tr> <td>B</td> <td>5.08</td> <td>10.16</td> <td>15.24</td> <td>17.78</td> <td>22.86</td> </tr> <tr> <td colspan="6"> </td> </tr> <tr> <td>No. of contacts</td> <td>24</td> <td>26</td> <td>30</td> <td>34</td> <td>40</td> </tr> <tr> <td>A</td> <td>35.18</td> <td>37.60</td> <td>42.70</td> <td>47.80</td> <td>55.40</td> </tr> <tr> <td>B</td> <td>27.94</td> <td>30.48</td> <td>35.56</td> <td>40.64</td> <td>48.26</td> </tr> <tr> <td colspan="6"> </td> </tr> <tr> <td>No. of contacts</td> <td>50</td> <td>60</td> <td>64</td> <td></td> <td></td> </tr> <tr> <td>A</td> <td>68.10</td> <td>80.80</td> <td>85.90</td> <td></td> <td></td> </tr> <tr> <td>B</td> <td>60.96</td> <td>73.66</td> <td>78.74</td> <td></td> <td></td> </tr> </table>		No. of contacts	6	10	14	16	20	A	12.20	17.30	22.40	24.90	30.00	B	5.08	10.16	15.24	17.78	22.86							No. of contacts	24	26	30	34	40	A	35.18	37.60	42.70	47.80	55.40	B	27.94	30.48	35.56	40.64	48.26							No. of contacts	50	60	64			A	68.10	80.80	85.90			B	60.96	73.66	78.74		
	No. of contacts	6	10			14	16	20																																																															
	A	12.20	17.30			22.40	24.90	30.00																																																															
	B	5.08	10.16			15.24	17.78	22.86																																																															
	No. of contacts	24	26			30	34	40																																																															
	A	35.18	37.60			42.70	47.80	55.40																																																															
	B	27.94	30.48			35.56	40.64	48.26																																																															
	No. of contacts	50	60			64																																																																	
	A	68.10	80.80			85.90																																																																	
	B	60.96	73.66			78.74																																																																	
	10	09 18 510 □ 813	09 18 510 □ 814*																																																																				
	14	09 18 514 □ 813	09 18 514 □ 814*																																																																				
	16	09 18 516 □ 813	09 18 516 □ 814*																																																																				
	20	09 18 520 □ 813	09 18 520 □ 814*																																																																				
24	09 18 524 □ 813																																																																						
26	09 18 526 □ 813	09 18 526 □ 814*																																																																					
30	09 18 530 □ 813	09 18 530 □ 814*																																																																					
34	09 18 534 □ 813	09 18 534 □ 814*																																																																					
40	09 18 540 □ 813	09 18 540 □ 814*																																																																					
50	09 18 550 □ 813	09 18 550 □ 814*																																																																					
60	09 18 560 □ 813	09 18 560 □ 814*																																																																					
64	09 18 564 □ 813	09 18 564 □ 814*																																																																					
with strain relief clamp with bulk packaging 3) Packaging unit (PU) 3,000 pieces 4) PU 2,500 pieces 5) PU 2,000 pieces 6) PU 1,500 pieces 7) PU 1,000 pieces	6	09 18 506 □ 813 58U ³⁾																																																																					
	10	09 18 510 □ 813 58U ³⁾																																																																					
	14	09 18 514 □ 813 58U ⁴⁾																																																																					
	16	09 18 516 □ 813 58U ⁴⁾																																																																					
	20	09 18 520 □ 813 58U ⁵⁾																																																																					
	26	09 18 526 □ 813 58U ⁶⁾																																																																					
	30	09 18 530 □ 813 58U ⁵⁾																																																																					
	40	09 18 540 □ 813 58U ⁷⁾																																																																					

SEK

08
22

For performance level 3 please specify digit 7
 For performance level 2 please specify digit 6
 S4 = 0.76 μm (30 μinch) Au or PdNi equivalent 5*



¹⁾ Pitch tolerance: ± 0.1
 * Not normally kept in stock

Number of contacts

6-64



Strain relief clamp/Locking lever

Identification	No. of contacts	Part number	Drawing	Dimensions in mm																												
Strain relief clamp	6	09 18 506 9002	<table border="1"> <thead> <tr> <th>No. of contacts</th> <th>A</th> </tr> </thead> <tbody> <tr><td>6</td><td>12.2</td></tr> <tr><td>10</td><td>17.3</td></tr> <tr><td>14</td><td>22.4</td></tr> <tr><td>16</td><td>24.9</td></tr> <tr><td>20</td><td>30.0</td></tr> <tr><td>24</td><td>35.18</td></tr> <tr><td>26</td><td>37.6</td></tr> <tr><td>30</td><td>42.7</td></tr> <tr><td>34</td><td>47.8</td></tr> <tr><td>40</td><td>55.4</td></tr> <tr><td>50</td><td>68.1</td></tr> <tr><td>60</td><td>80.8</td></tr> <tr><td>64</td><td>85.9</td></tr> </tbody> </table>	No. of contacts	A	6	12.2	10	17.3	14	22.4	16	24.9	20	30.0	24	35.18	26	37.6	30	42.7	34	47.8	40	55.4	50	68.1	60	80.8	64	85.9	
	No. of contacts	A																														
	6	12.2																														
	10	17.3																														
	14	22.4																														
	16	24.9																														
	20	30.0																														
	24	35.18																														
	26	37.6																														
	30	42.7																														
	34	47.8																														
	40	55.4																														
	50	68.1																														
	60	80.8																														
	64	85.9																														
	10	09 18 510 9002																														
	14	09 18 514 9002																														
	16	09 18 516 9002																														
	20	09 18 520 9002																														
	24	09 18 524 9002																														
26	09 18 526 9002																															
30	09 18 530 9002																															
34	09 18 534 9002																															
40	09 18 540 9002																															
50	09 18 550 9002																															
60	09 18 560 9002																															
64	09 18 564 9002																															
with bulk packaging	6	09 18 506 9002 58U ³⁾	6	12.2																												
	10	09 18 510 9002 58U ³⁾	10	17.3																												
	14	09 18 514 9002 58U ³⁾	14	22.4																												
	16	09 18 516 9002 58U ³⁾	16	24.9																												
	20	09 18 520 9002 58U ³⁾	20	30.0																												
	26	09 18 526 9002 58U ³⁾	26	37.6																												
	30	09 18 530 9002 58U ³⁾	30	42.7																												
	34	09 18 534 9002 58U ⁴⁾	34	47.8																												
	40	09 18 540 9002 58U ⁴⁾	40	55.4																												
³⁾ Packaging unit 5,000 pieces ⁴⁾ Packaging unit 3,000 pieces																																
Locking lever for female connector Only in conjunction with low-profile male header and strain relief ⁵⁾ Packaging unit 100 pieces ⁶⁾ Packaging unit 5,000 pieces		09 18 000 9905 ¹⁾⁵⁾ 09 18 000 9905 58U ¹⁾⁶⁾		When the security of latching is required and space is a premium, these locking levers can be fitted onto the strain relief of the HARTING female connector. This can then be used in conjunction with male low-profile headers (see pages 08.14 and 08.15).																												
Coding system with loss of contact Code pin Removal tool for male contacts		09 18 000 9901 ²⁾ 09 99 000 0133		To avoid cross-plugging adjacent connectors a coding system is required. A code pin is inserted into the appropriate cavity in the female connector. The corresponding male contact is removed by a special removal tool.																												

SEK

1) Order 2 per female connector
 2) Part number comprises 6 code pins

Number of contacts 4, 6, 8, 10, 14, 16, 20, 24, 26, 30, 34, 40, 50, 60, 64

Approvals



UL recognized: E102079

Pitch

On pcb side: 2.54 mm [0.100"]
On cable side: 1.27 mm [0.050"]

Rated current

2.6 A min. at ambient temperature of 30 °C

Working voltage

320 V
for pollution degree 1

Test voltage $U_{r.m.s.}$

1 kV AC – 1 minute

Contact resistance
Insulation resistance

35 mΩ max. mated
 $\geq 10^9 \Omega$

Temperature range

-55 °C ... +105 °C
The maximum temperature includes heating of contacts and ambient temperature

Terminations

Solder pins:
0.5 mm x 0.35 mm
Dimensions for pcb hole:
Standard version: $\varnothing 0.8^{\pm 0.1}$ mm
Kinked version: $\varnothing 0.85^{\pm 0.15}$ mm
Diagonal: 0.63 mm

IDC flat cable
1.27 mm [0.050"] pitch: AWG 28/7

Materials

Moulding Thermoplastic resin (PBT)
UL 94-V0

Contact Copper alloy

Current carrying capacity

The current carrying capacity is limited by maximum temperature of materials for inserts and contacts including terminals. The current capacity-curve is valid for continuous, not interrupted current-loaded contacts of connectors when simultaneous power on all contacts is given, without exceeding the maximum temperature. Control and test procedures according to IEC 60 512.

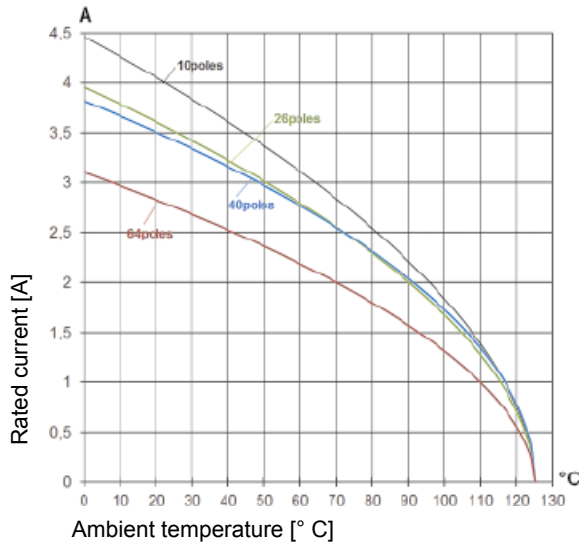

Derating curve at $I_{max.} \times 0.8$ (IEC 60512-2)

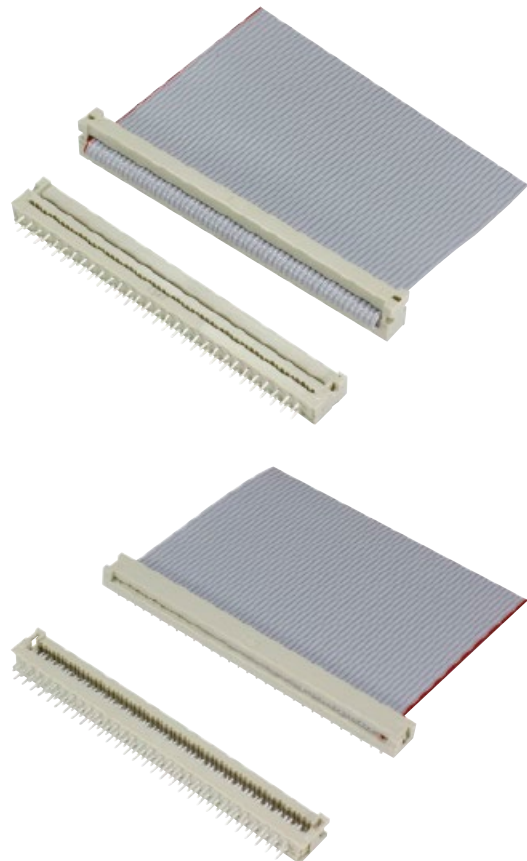

Number of contacts

4-64

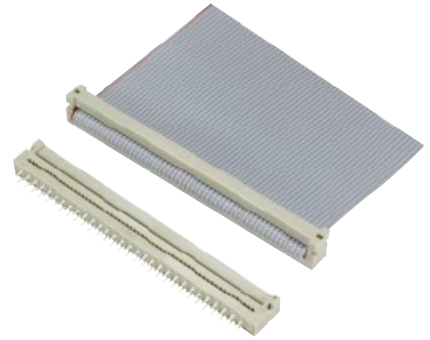

Pcb transition connector,
2 rows with strain relief clamp, low-profile with 5.5 mm height

Identification	No. of contacts	Part number	Drawing	Dimensions in mm
----------------	-----------------	-------------	---------	------------------

Pcb transition connector 2 rows with strain relief clamp Standard low-profile version	No. of contacts	Part number
	4	09 18 104 9623*
6	09 18 106 9623*	
8	09 18 108 9623*	
10	09 18 110 9623*	
14	09 18 114 9623*	
16	09 18 116 9623*	
20	09 18 120 9623*	
24	09 18 124 9623*	
26	09 18 126 9623*	
30	09 18 130 9623*	
34	09 18 134 9623*	
40	09 18 140 9623	
50	09 18 150 9623*	
60	09 18 160 9623	
64	09 18 164 9623*	

No. of contacts	A±0.38	B±0.10
4	10.38	2.54 x 1 = 2.54
6	12.92	2.54 x 2 = 5.08
8	15.46	2.54 x 3 = 7.62
10	18.00	2.54 x 4 = 10.16
14	23.08	2.54 x 6 = 15.24
16	25.62	2.54 x 7 = 17.78
20	30.74	2.54 x 9 = 22.86
24	35.78	2.54 x 11 = 27.94
26	38.32	2.54 x 12 = 30.48
30	43.40	2.54 x 14 = 35.56
34	48.48	2.54 x 16 = 40.64
40	56.10	2.54 x 19 = 48.26
50	68.80	2.54 x 24 = 60.96
60	81.50	2.54 x 29 = 73.66
64	86.58	2.54 x 31 = 78.74

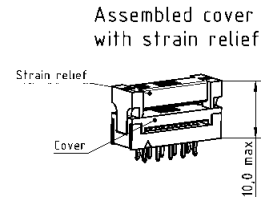

Pcb transition connector 2 rows with strain relief clamp Kinked low-profile version 2 kinked pins at each extremity	No. of contacts	Part number
	4	09 18 104 9423*
6	09 18 106 9423*	
8	09 18 108 9423*	
10	09 18 110 9423*	
14	09 18 114 9423*	
16	09 18 116 9423*	
20	09 18 120 9423*	
24	09 18 124 9423*	
26	09 18 126 9423*	
30	09 18 130 9423*	
34	09 18 134 9423*	
40	09 18 140 9423	
50	09 18 150 9423*	
60	09 18 160 9423	
64	09 18 164 9423*	

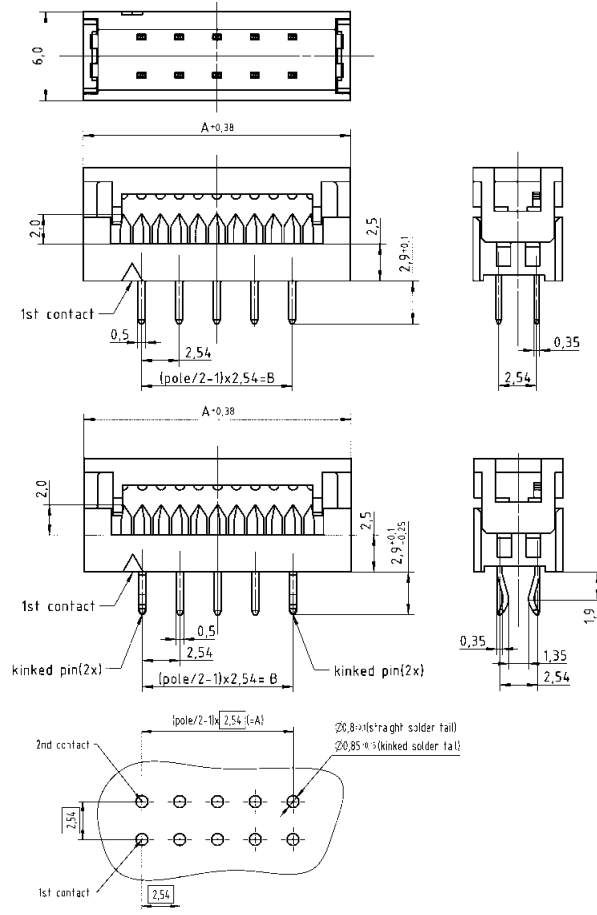

Board drillings

SEK

Not released for halogen free flat cables
* Available on request

Number of contacts

4-64

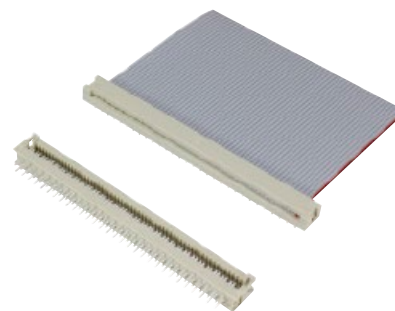

Pcb transition connector,
2 rows without strain relief clamp, low-profile with 5.5 mm height

Identification	No. of contacts	Part number	Drawing	Dimensions in mm
----------------	-----------------	-------------	---------	------------------

Pcb transition connector
2 rows without strain relief clamp
Standard low-profile version

No. of contacts	Part number
4	09 18 104 9622
6	09 18 106 9622
8	09 18 108 9622
10	09 18 110 9622
14	09 18 114 9622
16	09 18 116 9622
20	09 18 120 9622
24	09 18 124 9622
26	09 18 126 9622
30	09 18 130 9622
34	09 18 134 9622
40	09 18 140 9622
50	09 18 150 9622
60	09 18 160 9622
64	09 18 164 9622

No. of contacts	A±0.38	B±0.10
4	10.38	2.54 x 1 = 2.54
6	12.92	2.54 x 2 = 5.08
8	15.46	2.54 x 3 = 7.62
10	18.00	2.54 x 4 = 10.16
14	23.08	2.54 x 6 = 15.24
16	25.62	2.54 x 7 = 17.78
20	30.74	2.54 x 9 = 22.86
24	35.78	2.54 x 11 = 27.94
26	38.32	2.54 x 12 = 30.48
30	43.40	2.54 x 14 = 35.56
34	48.48	2.54 x 16 = 40.64
40	56.10	2.54 x 19 = 48.26
50	68.80	2.54 x 24 = 60.96
60	81.50	2.54 x 29 = 73.66
64	86.58	2.54 x 31 = 78.74

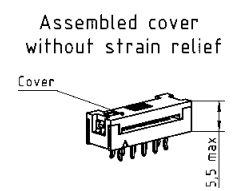

Pcb transition connector
2 rows without strain relief clamp
Kinked low-profile version
2 kinked pins at each extremity

No. of contacts	Part number
4	09 18 104 9422
6	09 18 106 9422
8	09 18 108 9422
10	09 18 110 9422
14	09 18 114 9422
16	09 18 116 9422
20	09 18 120 9422
24	09 18 124 9422
26	09 18 126 9422
30	09 18 130 9422
34	09 18 134 9422
40	09 18 140 9422
50	09 18 150 9422
60	09 18 160 9422
64	09 18 164 9422

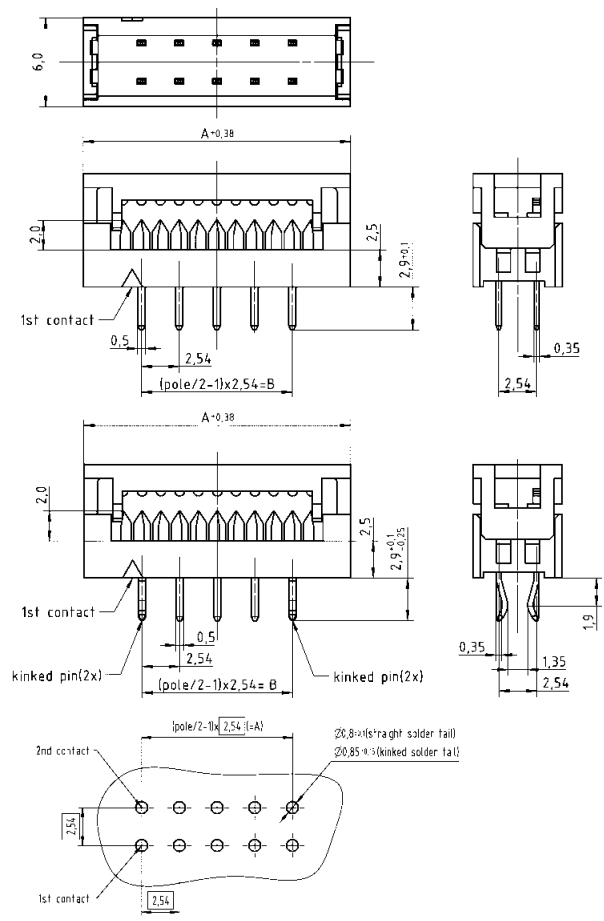

Board drillings

SEK

Number of contacts

4-64



Strain relief clamp

Identification	No. of contacts	Part number	Drawing	Dimensions in mm
----------------	-----------------	-------------	---------	------------------

Strain relief clamp

4	98 18 104 9002*
6	98 18 106 9002*
8	98 18 108 9002*
10	98 18 110 9002*
14	98 18 114 9002*
16	98 18 116 9002*
20	98 18 120 9002*
24	98 18 124 9002*
26	98 18 126 9002*
30	98 18 130 9002*
34	98 18 134 9002*
40	98 18 140 9002
50	98 18 150 9002*
60	98 18 160 9002
64	98 18 164 9002*

No. of contacts	A	B	C
4	10.38	8.58	5.98
6	12.92	11.12	8.52
8	15.46	13.66	11.06
10	18.00	16.20	13.60
14	23.08	21.28	18.68
16	25.62	23.82	21.22
20	30.70	28.90	26.30
24	35.78	33.98	31.38
26	38.32	36.52	33.92
30	43.40	41.60	39.00
34	48.48	46.68	44.08
40	56.10	54.30	51.70
50	68.80	67.00	64.40
60	81.50	79.70	77.10
64	86.58	84.78	82.18

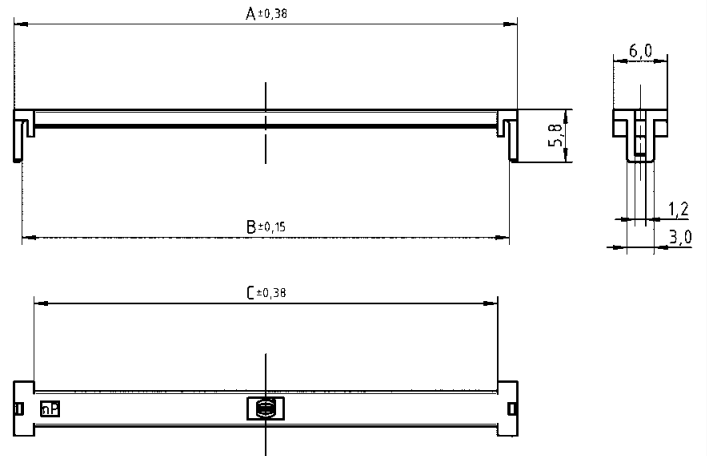

* Available on request

Number of contacts* 10, 16, 20, 26, 34, 40, 50

Pitch
On pcb side: 2.54 mm [0.100"]
On cable side: 1.27 mm [0.050"]

Working current 1 A

Test voltage $U_{r.m.s.}$ 500 V

Contact resistance $\leq 20 \text{ m}\Omega$
Insulation resistance $\geq 10^{12} \Omega$

Temperature range -40 °C ... +125 °C
The maximum temperature includes heating of contacts and ambient temperature

Terminations
Solder pins
0.45 mm x 0.35 mm
for pcb hole \varnothing 0.8 mm
Diagonal: 0.58 mm
IDC flat cable
1.27 mm [0.050"] pitch:
AWG 28/7

Materials
Moulding Thermoplastic resin (PC)
UL 94-V0



Number of contacts

10-50



Pcb transition connector, 4 rows

Identification	No. of contacts	Part number	Drawing	Dimensions in mm
----------------	-----------------	-------------	---------	------------------

Pcb transition connector²⁾
4 rows

10	09 19 010 9643*
16	09 19 016 9643*
20	09 19 020 9643*
26	09 19 026 9643*
34	09 19 034 9643*
40	09 19 040 9643*
50	09 19 050 9643*

No. of contacts	A	B
10	17.78	1.27 x 9 = 11.43
16	25.40	1.27 x 15 = 19.05
20	30.48	1.27 x 19 = 24.13
26	38.10	1.27 x 25 = 31.75
34	48.26	1.27 x 33 = 41.91
40	55.88	1.27 x 39 = 49.53
50	68.58	1.27 x 49 = 62.23

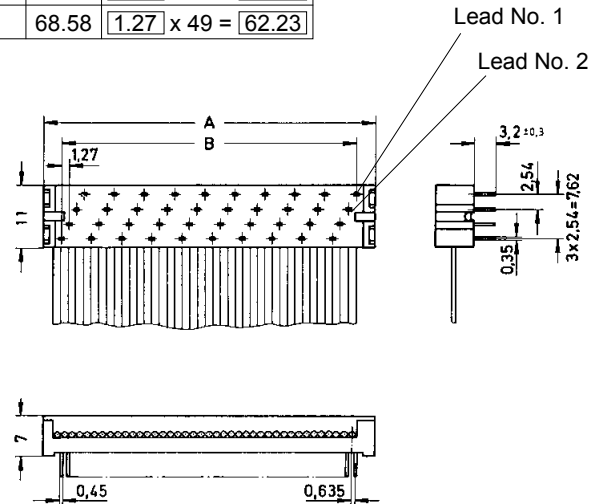

Board drillings

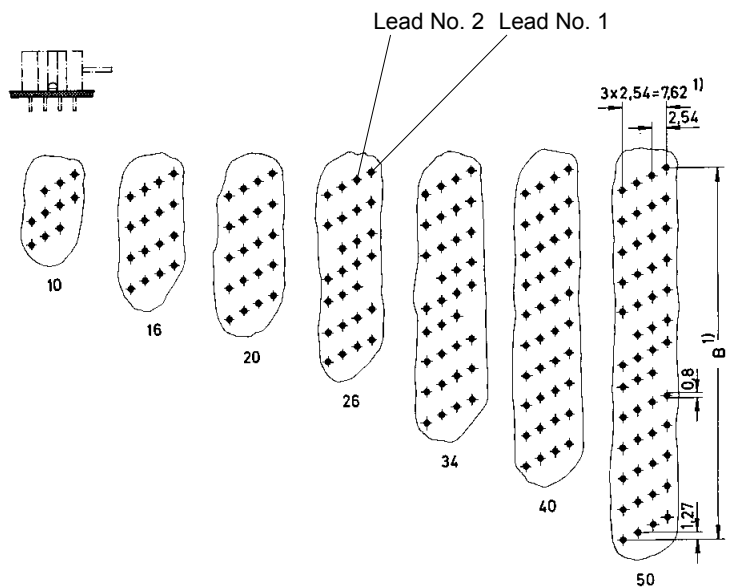

* Not normally kept in stock.

¹⁾ Pitch tolerance: ± 0.1

²⁾ Not released for halogen free flat cables

Number of contacts*	14, 16, 24, 28, 40
Pitch	On pcb side: 2.54 mm [0.100"] On cable side: 1.27 mm [0.050"]
Working current	1 A
Test voltage $U_{r.m.s.}$	500 V
Contact resistance Insulation resistance	$\leq 20 \text{ m}\Omega$ $\geq 10^{12} \Omega$
Temperature range	-40 °C ... +125 °C The maximum temperature includes heating of contacts and ambient temperature
Terminations	Solder pins 0.45 mm x 0.35 mm for pcb hole \varnothing 0.8 mm Diagonal: 0.58 mm IDC flat cable 1.27 mm [0.050"] pitch: AWG 28/7
Materials Moulding	Thermoplastic resin (PC) UL 94-V0

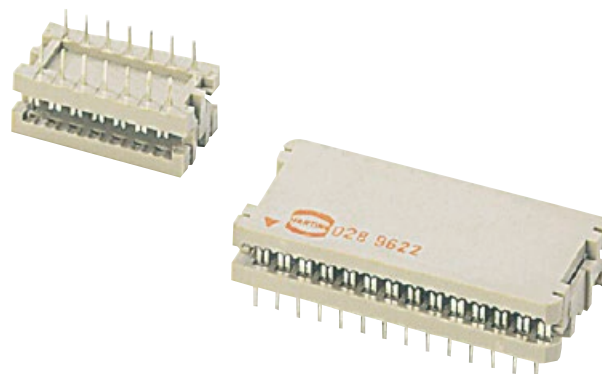

Number of contacts

14-40



DIP connector for IC base or for soldering into pcb

Identification No. of contacts Part number Drawing Dimensions in mm

DIP connector²⁾

14	09 17 014 9622*
16	09 17 016 9622*
24	09 17 024 9622*
28	09 17 028 9622*
40	09 17 040 9622*

No. of contacts	A	B	C	D
14	20.5	2.54 x 6 = 15.24	11	7.62
16	23.0	2.54 x 7 = 17.78	11	7.62
24	33.0	2.54 x 11 = 27.94	18.7	15.24
28	38.1	2.54 x 13 = 33.02	18.7	15.24
40	53.3	2.54 x 19 = 48.26	18.7	15.24

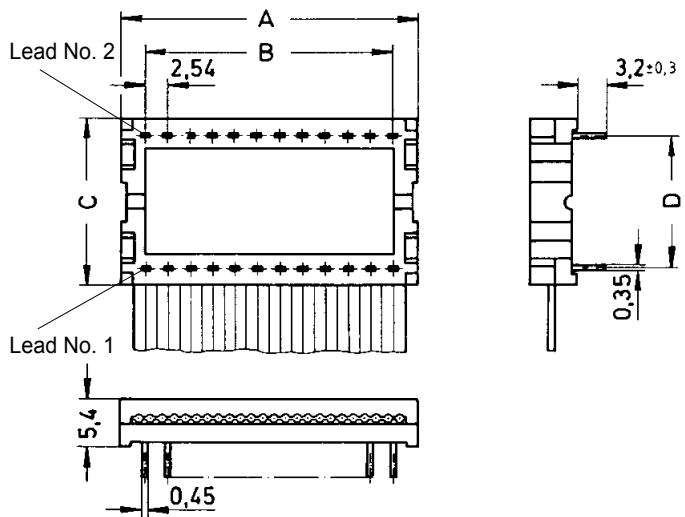

Board drillings

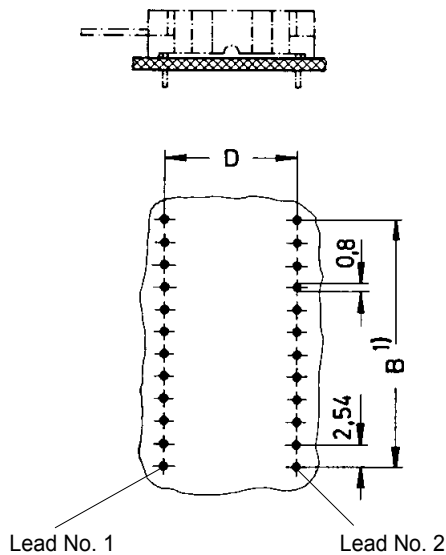

* Not normally kept in stock

¹⁾ Pitch tolerance: ± 0.1

²⁾ Not released for halogen free flat cables

SEK

Number of contacts	64
Pitch	2.54 mm [0.100"]
Working current	1 A max.
Clearance Creepage	≥ 1.2 mm ≥ 1.2 mm
Working voltage	according to the safety regulations of the equipment
<p>The working voltage also depends on the clearance and creepage dimensions of the pcb itself, and the associated wiring</p>	
Test voltage $U_{r.m.s.}$	1 kV
Contact resistance	≤ 20 mΩ
Insulation resistance	≥ 10 ¹² Ω
Temperature range	-55 °C ... +125 °C The maximum temperature includes heating of contacts and ambient temperature
Termination	
Female connector	Insulation displacement: AWG 28/7
Insertion and withdrawal force	≤ 60 N
Materials	
Moulding	Thermoplastic resin, glass-fibre filled, UL 94-V0
Contacts	Copper alloy
Contact surface	
Contact zone	selectively plated according to performance level



Number of contacts

64

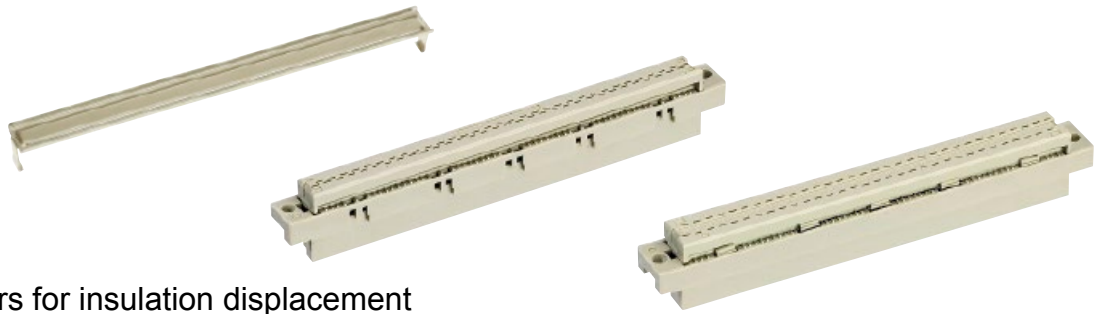

Female connectors for insulation displacement

Identification	No. of contacts	Part number	Drawing	Dimensions in mm									
Female connector for insulation displacement Type B	64	performance level 2 09 02 264 6828	<p>Lead number 1 of flat cable on contact 1 b</p> <p>Contact arrangement View from termination side</p>										
		performance level 3 09 02 264 7828											
Type C	64	performance level 2 09 03 264 6828 09 03 764 6828 ^{c)}	<p>Lead number 1 of flat cable on contact 1 c</p> <p>Contact arrangement View from termination side</p>										
		performance level 3 09 03 264 7828											
Strain relief for types B and C		09 03 000 9940	<p>Mateable with 3-row male connector Type C. No female contact in middle row.</p> <p>Panel cut out</p>										
			<table border="1"> <thead> <tr> <th></th> <th>a</th> <th>b</th> </tr> </thead> <tbody> <tr> <td>Type B</td> <td>8.3</td> <td>10.16</td> </tr> <tr> <td>Type C</td> <td>10.8</td> <td>12.7</td> </tr> </tbody> </table>		a	b	Type B	8.3	10.16	Type C	10.8	12.7	
	a	b											
Type B	8.3	10.16											
Type C	10.8	12.7											

SEK



Number of contacts 6, 10, 14, 16, 20, 26, 34, 40, 50, 60, 64

Contact arrangement straight

Contact length 5.5 mm

Approvals IEC 60603-13
DIN EN 60603-13
D 2632
BT 224
NFC 93-428 (HE 10)
UL recognized: E102079



Pitch 2.54 mm [0.100"]

Working current 1 A

Test voltage $U_{r.m.s.}$ 1 kV

Contact resistance $\leq 20 \text{ m}\Omega$
Insulation resistance $\geq 10^9 \Omega$

Temperature range -55 °C ... +105 °C
The maximum temperature includes heating of contacts and ambient temperature

Press-in
Diameter of pcb plated through holes $\varnothing 1.0^{+0.09}_{-0.06} \text{ mm}$
Recommended pcb holes for press-in process
Hole: $\varnothing 1.12 - 1.15 \text{ mm}$
Cu : 25 – 75 μm
Sn : 5 – 15 μm
Pcb thickness 1.6 – 3.2 mm

Materials Moulding Thermoplastic resin (PBT)
UL 94-V0

Contact surface Contact zone plated according to performance level¹⁾

Insertion and withdrawal forces

Number of contacts	Maximum force [N]	
	Performance level 1 and 2	Performance level 3
6	12	18
10	20	30
14	28	42
16	32	48
20	40	60
26	52	78
34	68	102
40	80	120
50	100	150
60	120	180
64	128	192

¹⁾ Performance level 3 as per IEC 60603-13, ≥ 50 mating cycles, no gas test
Performance level 2 as per IEC 60603-13, ≥ 250 mating cycles, 4 days gas test
S4, plating = 0.76 μm (30 μinch) Au or PdNi equivalent

Number of contacts

6-64

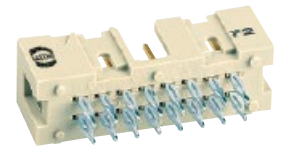

Low-profile male header, straight press-in pins

Identification	No. of contacts	Part number	Drawing	Dimensions in mm
----------------	-----------------	-------------	---------	------------------

Low-profile male header with straight press-in terminations
Length: 5.5 mm

6	09 18 506 □ 329
10	09 18 510 □ 329
14	09 18 514 □ 329
16	09 18 516 □ 329
20	09 18 520 □ 329
26	09 18 526 □ 329
34	09 18 534 □ 329
40	09 18 540 □ 329
50	09 18 550 □ 329
60	09 18 560 □ 329
64	09 18 564 □ 329

No. of contacts	A	B	E
6	15.2	12.78	2.54 x 2 = 5.08
10	20.3	17.86	2.54 x 4 = 10.16
14	25.4	22.94	2.54 x 6 = 15.24
16	27.9	25.48	2.54 x 7 = 17.78
20	33.0	30.56	2.54 x 9 = 22.86
26	40.6	38.18	2.54 x 12 = 30.48
34	50.8	48.34	2.54 x 16 = 40.64
40	58.4	55.96	2.54 x 19 = 48.26
50	71.3	68.66	2.54 x 24 = 60.96
60	84.0	81.36	2.54 x 29 = 73.66
64	89.1	86.44	2.54 x 31 = 78.74

Marking No. 1 contact

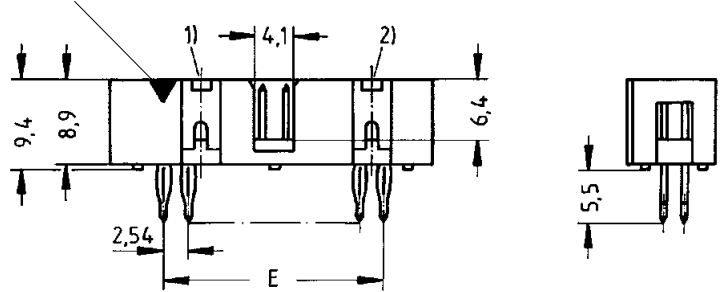

No. 2 contact

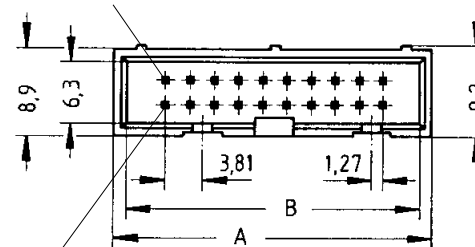

No. 1 contact

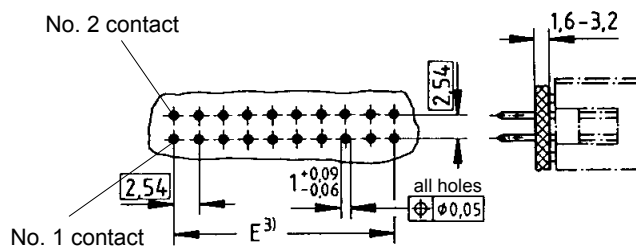

Board drillings

For Performance Level 3 please specify digit 7
For Performance Level 2 please specify digit 6
S4 = 0.76 μm (30 μinch) Au or PdNi equivalent



Not normally kept in stock

- 1) No polarization slot for 6, 10 or 14 way
- 2) No polarization slot for 6 way
- 3) Pitch tolerance: ± 0.1

Number of contacts 6, 10, 14, 16, 20, 24, 26, 30, 34, 40, 50, 60, 64

Contact arrangement straight, angled

Contact length 2.9 mm

Approvals IEC 60603-13
DIN EN 60603-13
D 2632
BT 224
NFC 93-428 (HE 10)

Pitch 2.54 mm [0.100"]

Working current 1 A

Working voltage 500 V
for pollution degree 1

Test voltage $U_{r.m.s.}$ 1 kV

Contact resistance $\leq 20 \text{ m}\Omega$
Insulation resistance $\geq 10^9 \Omega$

Temperature range -55 °C ... +125 °C
during reflow soldering max. + 240 °C for 60 s
The higher temperature limit includes the local ambient and heating effect of the contacts under load

Terminations For pcb hole $\varnothing 1 \pm 0.1 \text{ mm}$
DIN IEC 52 141
Diagonal: 0.79 mm

Materials Moulding Thermoplastic resin (PCT)
UL 94-V0

Contact surface Contact zone gold-plated according to performance level¹⁾

Options on request

Colour of connectors black

For pick & place process Tape & Reel packaging
with/without vacuum plate
Tube packaging
with/without vacuum plate



Insertion and withdrawal forces

Number of contacts	Maximum force [N]	
	Performance level 1 and 2	Performance level 3
6	12	18
10	20	30
14	28	42
16	32	48
20	40	60
24	48	72
26	52	78
30	60	90
34	68	102
40	80	120
50	100	150
60	120	180
64	128	192



¹⁾ Performance level 3 as per IEC 60603-13, ≥ 50 mating cycles, no gas test
Performance level 2 as per IEC 60603-13, ≥ 250 mating cycles, 4 days gas test
S4, plating = 0.76 μm (30 μinch) Au or PdNi equivalent

Graphical grid area for taking notes.

Number of contacts

6-64

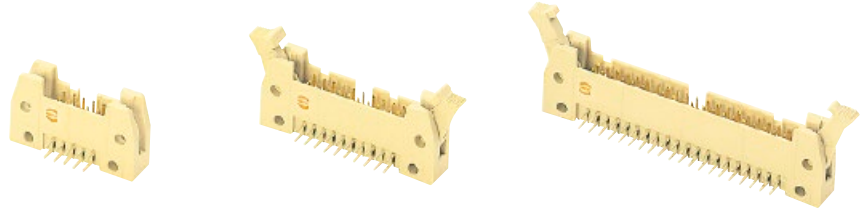

SMC male header with angled solder pins

Identification	No. of contacts	Part number		
		Without levers	With short levers	With long levers
SMC male header with angled solder pins Length: 2.9 mm				
	6	09 19 506 □ 923	09 19 506 □ 913	09 19 506 □ 903
	10	09 19 510 □ 923	09 19 510 □ 913	09 19 510 □ 903
	14	09 19 514 □ 923	09 19 514 □ 913	09 19 514 □ 903
	16	09 19 516 □ 923	09 19 516 □ 913	09 19 516 □ 903
	20	09 19 520 □ 923	09 19 520 □ 913	09 19 520 □ 903
	24	09 19 524 □ 923	09 19 524 □ 913	09 19 524 □ 903
	26	09 19 526 □ 923	09 19 526 □ 913	09 19 526 □ 903
	30	09 19 530 □ 923	09 19 530 □ 913	09 19 530 □ 903
	34	09 19 534 □ 923	09 19 534 □ 913	09 19 534 □ 903
	40	09 19 540 □ 923	09 19 540 □ 913	09 19 540 □ 903
	50	09 19 550 □ 923	09 19 550 □ 913	09 19 550 □ 903
	60	09 19 560 □ 923	09 19 560 □ 913	09 19 560 □ 903
	64	09 19 564 □ 923	09 19 564 □ 913	09 19 564 □ 903

SEK

Kinked version on request

* Not normally kept in stock
For accessories see page 08.48
For dimensions see page 08.39

For performance level 3 please specify digit $\begin{matrix} 7 \\ 6 \\ 5 \end{matrix}$ *
For performance level 2 please specify digit $\begin{matrix} 7 \\ 6 \\ 5 \end{matrix}$ *
S4 = 0.76 µm (30 µinch) Au or PdNi equivalent



Number of contacts

6-64

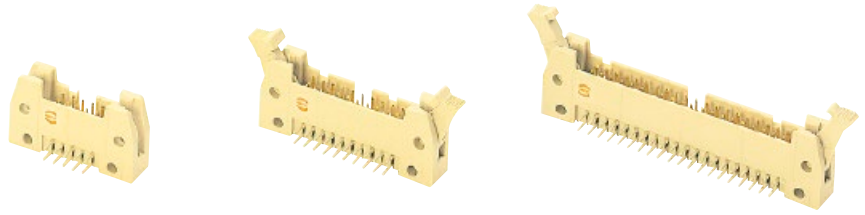

SMC male header with angled solder pins

Identification

Drawing

Dimensions in mm

SMC male header

No. of contacts	A	B	D	E	F	G
6	26.9	16.76	12.45	2.54 x 2 = 5.08	36.9	40.3
10	32.0	21.84	17.53	2.54 x 4 = 10.16	42.0	45.4
14	37.1	26.92	22.61	2.54 x 6 = 15.24	47.1	50.4
16	39.6	29.46	25.15	2.54 x 7 = 17.78	49.6	53.0
20	44.7	34.54	30.23	2.54 x 9 = 22.86	54.7	58.1
24	49.8	39.62	35.91	2.54 x 11 = 27.94	59.8	63.2
26	52.3	42.16	37.85	2.54 x 12 = 30.48	62.3	65.7
30	57.7	47.24	43.83	2.54 x 14 = 35.56	68.2	68.6
34	62.5	52.32	48.01	2.54 x 16 = 40.64	72.5	75.8
40	70.1	59.94	55.63	2.54 x 19 = 48.26	80.1	83.5
50	82.8	72.64	68.33	2.54 x 24 = 60.96	92.8	96.2
60	95.5	85.34	81.03	2.54 x 29 = 73.66	105.5	108.9
64	100.6	90.42	86.11	2.54 x 31 = 78.74	110.6	113.9

Short levers

for use with female connector without strain relief clamp

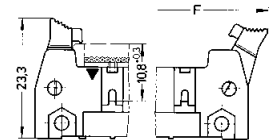
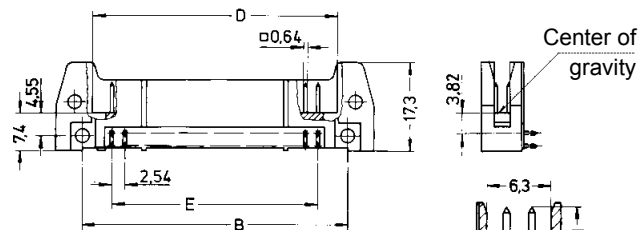

Long levers

for use with female connector with strain relief clamp

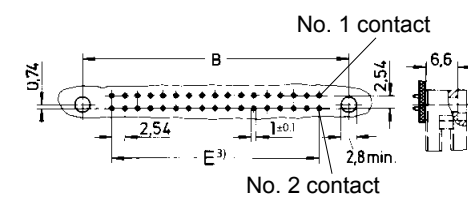
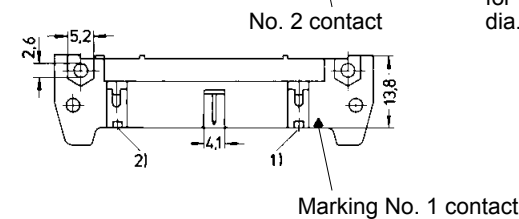
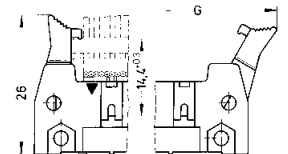
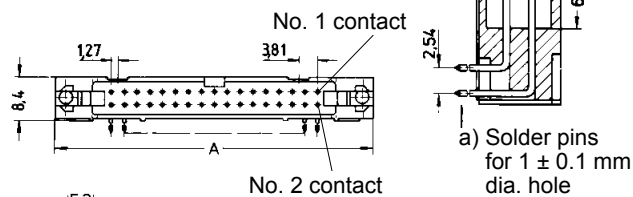

Board drillings

1) No polarization slot for 6, 10 or 14 way male header

2) No polarization slot for 6 way male header

3) Pitch tolerance: ± 0.1

Number of contacts

6-64

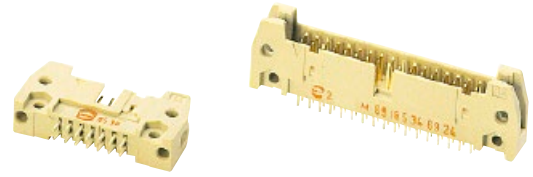

SMC male header with straight solder pins

Identification	No. of contacts	Part number		
		Without levers	With short levers	With long levers
SMC male header with straight solder pins Length: 2.9 mm				
	6	09 19 506 □ 924	09 19 506 □ 914	09 19 506 □ 904
	10	09 19 510 □ 924	09 19 510 □ 914	09 19 510 □ 904
	14	09 19 514 □ 924	09 19 514 □ 914	09 19 514 □ 904
	16	09 19 516 □ 924	09 19 516 □ 914	09 19 516 □ 904
	20	09 19 520 □ 924	09 19 520 □ 914	09 19 520 □ 904
	24	09 19 524 □ 924	09 19 524 □ 914	09 19 524 □ 904
	26	09 19 526 □ 924	09 19 526 □ 914	09 19 526 □ 904
	30	09 19 530 □ 924	09 19 530 □ 914	09 19 530 □ 904
	34	09 19 534 □ 924	09 19 534 □ 914	09 19 534 □ 904
	40	09 19 540 □ 924	09 19 540 □ 914	09 19 540 □ 904
	50	09 19 550 □ 924	09 19 550 □ 914	09 19 550 □ 904
	60	09 19 560 □ 924	09 19 560 □ 914	09 19 560 □ 904
	64	09 19 564 □ 924	09 19 564 □ 914	09 19 564 □ 904

SEK

* Not normally kept in stock
For accessories see page 08.48
For dimensions see page 08.41

For performance level 3 please specify digit 7*
For performance level 2 please specify digit 6*
S4 = 0.76 µm (30 µinch) Au or PdNi equivalent 5*



Number of contacts

6-64

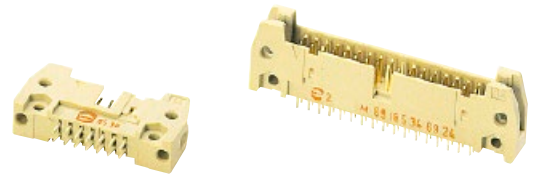

SMC male header with straight solder pins

Identification

Drawing

Dimensions in mm

SMC male header

No. of contacts	A	C	D	E	F	G
6	26.9	22.86	12.45	2.54 x 2 = 5.08	36.9	40.3
10	32.0	27.94	17.53	2.54 x 4 = 10.16	42.0	45.4
14	37.1	33.02	22.61	2.54 x 6 = 15.24	47.1	50.4
16	39.6	35.56	25.15	2.54 x 7 = 17.78	49.6	53.0
20	44.7	40.64	30.23	2.54 x 9 = 22.86	54.7	58.1
24	49.8	45.72	35.91	2.54 x 11 = 27.94	59.8	63.2
26	52.3	48.26	37.85	2.54 x 12 = 30.48	62.3	65.7
30	57.7	53.34	43.83	2.54 x 14 = 35.56	68.2	68.6
34	62.5	58.42	48.01	2.54 x 16 = 40.64	72.5	75.8
40	70.1	66.04	55.63	2.54 x 19 = 48.26	80.1	83.5
50	82.8	78.74	68.33	2.54 x 24 = 60.96	92.8	96.2
60	95.5	91.44	81.03	2.54 x 29 = 73.66	105.5	108.9
64	100.6	96.52	86.11	2.54 x 31 = 78.74	110.6	113.9

Short levers

for use with female connector without strain relief clamp

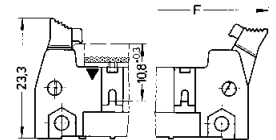
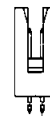
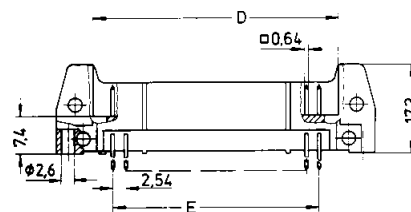

Long levers

for use with female connector with strain relief clamp

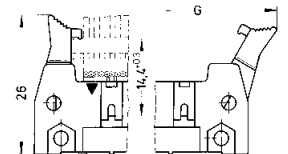
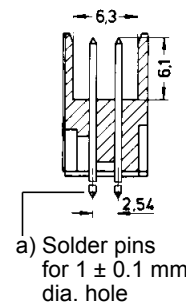
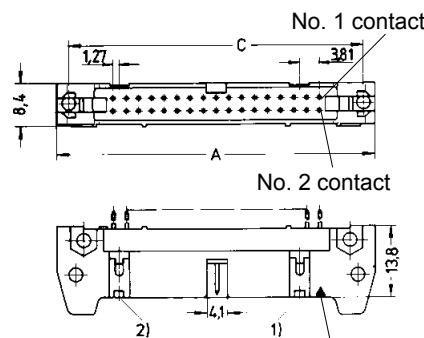

Marking No. 1 contact

Board drillings

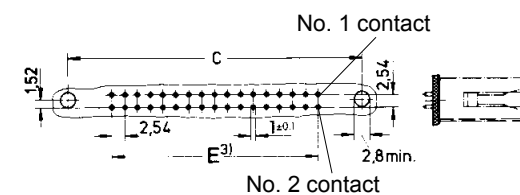

1) No polarization slot for 6, 10 or 14 way male header

2) No polarization slot for 6 way male header

3) Pitch tolerance: ± 0.1

Number of contacts

6-64

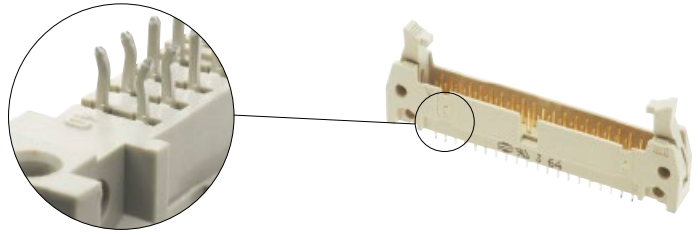

SMC male header with straight solder pins, kinked

Identification	No. of contacts	Part number		
		Without levers	With short levers	With long levers
SMC male header with straight solder pins, kinked Length: 2.9 mm	6	09 19 506 □ 024	09 19 506 □ 014	09 19 506 □ 004
	10	09 19 510 □ 024	09 19 510 □ 014	09 19 510 □ 004
	14	09 19 514 □ 024	09 19 514 □ 014	09 19 514 □ 004
	16	09 19 516 □ 024	09 19 516 □ 014	09 19 516 □ 004
	20	09 19 520 □ 024	09 19 520 □ 014	09 19 520 □ 004
	24	09 19 524 □ 024	09 19 524 □ 014	09 19 524 □ 004
	26	09 19 526 □ 024	09 19 526 □ 014	09 19 526 □ 004
	30	09 19 530 □ 024	09 19 530 □ 014	09 19 530 □ 004
	34	09 19 534 □ 024	09 19 534 □ 014	09 19 534 □ 004
	40	09 19 540 □ 024	09 19 540 □ 014	09 19 540 □ 004
	50	09 19 550 □ 024	09 19 550 □ 014	09 19 550 □ 004
	60	09 19 560 □ 024	09 19 560 □ 014	09 19 560 □ 004
	64	09 19 564 □ 024	09 19 564 □ 014	09 19 564 □ 004

SEK

* Not normally kept in stock
For accessories see page 08.48
For dimensions see page 08.43

For performance level 3 please specify digit 7*
For performance level 2 please specify digit 6*
S4 = 0.76 µm (30 µinch) Au or PdNi equivalent



Number of contacts

6-64

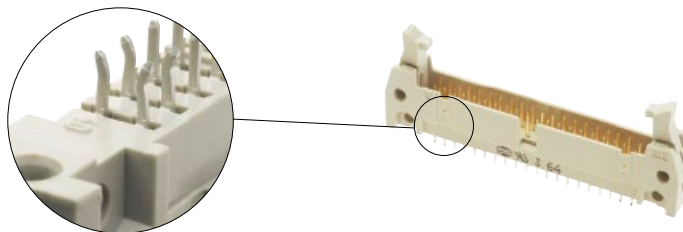

SMC male header with straight solder pins, kinked

Identification

Drawing

Dimensions in mm

SMC male header

No. of contacts	A	C	D	E	F	G
6	26.9	22.86	12.45	2.54 x 2 = 5.08	36.9	40.3
10	32.0	27.94	17.53	2.54 x 4 = 10.16	42.0	45.4
14	37.1	33.02	22.61	2.54 x 6 = 15.24	47.1	50.4
16	39.6	35.56	25.15	2.54 x 7 = 17.78	49.6	53.0
20	44.7	40.64	30.23	2.54 x 9 = 22.86	54.7	58.1
24	49.8	45.72	35.91	2.54 x 11 = 27.94	59.8	63.2
26	52.3	48.26	37.85	2.54 x 12 = 30.48	62.3	65.7
30	57.7	53.34	43.83	2.54 x 14 = 35.56	68.2	68.6
34	62.5	58.42	48.01	2.54 x 16 = 40.64	72.5	75.8
40	70.1	66.04	55.63	2.54 x 19 = 48.26	80.1	83.5
50	82.8	78.74	68.33	2.54 x 24 = 60.96	92.8	96.2
60	95.5	91.44	81.03	2.54 x 29 = 73.66	105.5	108.9
64	100.6	96.52	86.11	2.54 x 31 = 78.74	110.6	113.9

Short levers

for use with female connector without strain relief clamp

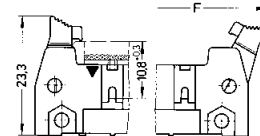
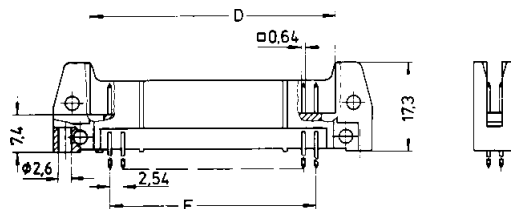

Long levers

for use with female connector with strain relief clamp

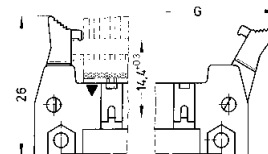
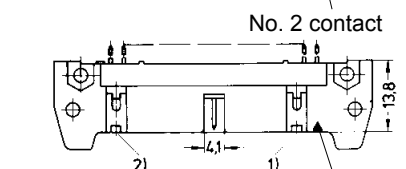
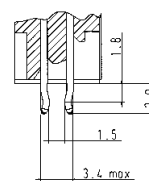
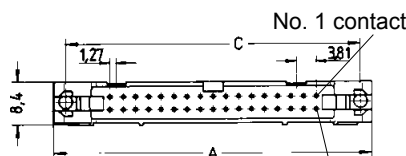

Marking No. 1 contact

No. 1 contact

Board drillings

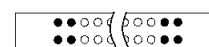
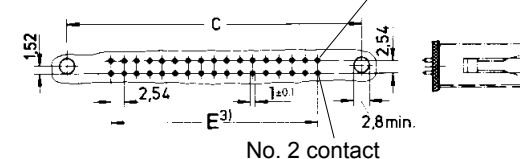

● Kinked contact: pcb thickness from 1.50 to 1.94 mm after Cu + Sn plating with non-remelted through holes \varnothing 0.80 to \varnothing 0.95 mm. Max. insertion force = 125 N. Min. retention force = 6 N.

○ Non-kinked contact: Solder pins for pcb connections \varnothing 1 ± 0.1 mm as per IEC 60603-13.

¹⁾ No polarization slot for 6, 10 or 14 way male header

²⁾ No polarization slot for 6 way male header

³⁾ Pitch tolerance: ± 0.1

SEK

Number of contacts

6-64

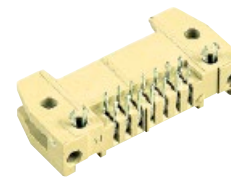

SMC male header with angled solder pins and board lock

Identification	No. of contacts	Part number		
		Without levers	With short levers	With long levers
SMC male header with angled solder pins and pcb board lock Length: 2.9 mm for 1.6 mm pcb thickness To hold the connector on the pcb before the soldering process, two board locks have been added on the male header with angled solder pins.	6	09 19 506 □ 973*	09 19 506 □ 963*	09 19 506 □ 953*
	10	09 19 510 □ 973*	09 19 510 □ 963*	09 19 510 □ 953*
	14	09 19 514 □ 973*	09 19 514 □ 963*	09 19 514 □ 953*
	16	09 19 516 □ 973*	09 19 516 □ 963*	09 19 516 □ 953*
	20	09 19 520 □ 973*	09 19 520 □ 963*	09 19 520 □ 953*
	24	09 19 524 □ 973*	09 19 524 □ 963*	09 19 524 □ 953*
	26	09 19 526 □ 973*	09 19 526 □ 963*	09 19 526 □ 953*
	30	09 19 530 □ 973*	09 19 530 □ 963*	09 19 530 □ 953*
	34	09 19 534 □ 973*	09 19 534 □ 963*	09 19 534 □ 953*
	40	09 19 540 □ 973*	09 19 540 □ 963*	09 19 540 □ 953*
	50	09 19 550 □ 973*	09 19 550 □ 963*	09 19 550 □ 953*
	60	09 19 560 □ 973*	09 19 560 □ 963*	09 19 560 □ 953*
	64	09 19 564 □ 973*	09 19 564 □ 963*	09 19 564 □ 953*

SEK

* Not normally kept in stock

For performance level 3 please specify digit 7
 For performance level 2 please specify digit 6
 S4 = 0.76 µm (30 µinch) Au or PdNi equivalent

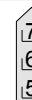
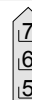
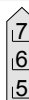

Number of contacts

6-64

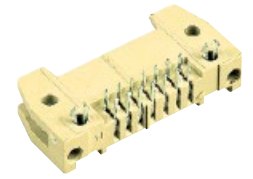

SMC male header with angled solder pins and board lock

Identification

Drawing

Dimensions in mm

SMC male header

No. of contacts	A	B	D	E	F	G
6	26.9	16.76	12.45	2.54 x 2 = 5.08	36.9	40.3
10	32.0	21.84	17.53	2.54 x 4 = 10.16	42.0	45.4
14	37.1	26.92	22.61	2.54 x 6 = 15.24	47.1	50.4
16	39.6	29.46	25.15	2.54 x 7 = 17.78	49.6	53.0
20	44.7	34.54	30.23	2.54 x 9 = 22.86	54.7	58.1
24	49.8	39.62	35.91	2.54 x 11 = 27.94	59.8	63.2
26	52.3	42.16	37.85	2.54 x 12 = 30.48	62.3	65.7
30	57.7	47.24	43.83	2.54 x 14 = 35.56	68.2	68.6
34	62.5	52.32	48.01	2.54 x 16 = 40.64	72.5	75.8
40	70.1	59.94	55.63	2.54 x 19 = 48.26	80.1	83.5
50	82.8	72.64	68.33	2.54 x 24 = 60.96	92.8	96.2
60	95.5	85.34	81.03	2.54 x 29 = 73.66	105.5	108.9
64	100.6	90.42	86.11	2.54 x 31 = 78.74	110.6	113.9

Short levers

for use with female connector without strain relief clamp

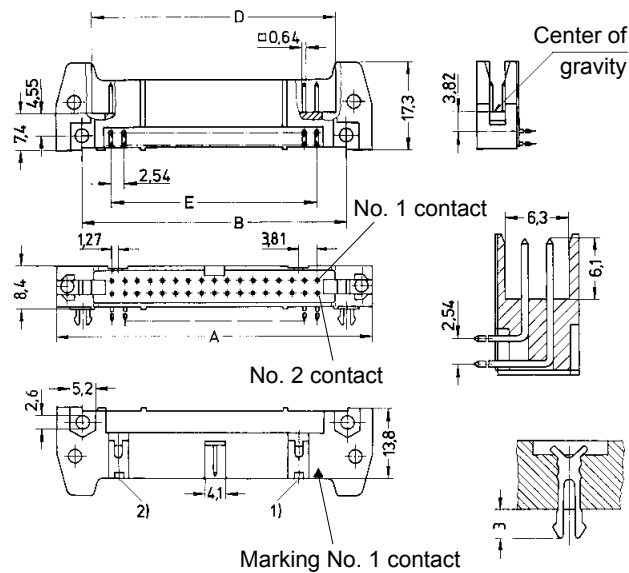

Long levers

for use with female connector with strain relief clamp

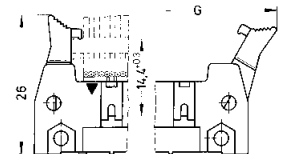

Board drillings

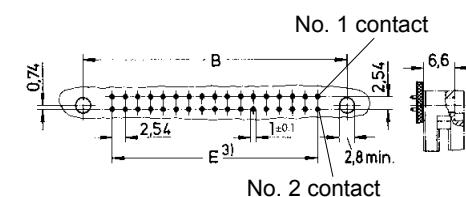

For accessories see page 08.48

1) No polarization slot for 6, 10 or 14 way male header

2) No polarization slot for 6 way male header

3) Pitch tolerance: ± 0.1

Number of contacts

6-64



Tape & Reel packaging

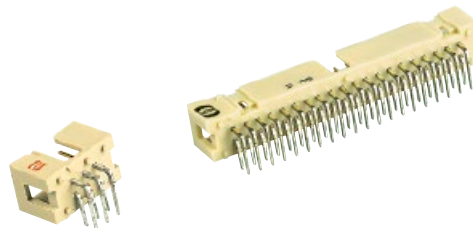

SMC low-profile male header, angled solder pins

Identification	No. of contacts	Part number	Drawing	Dimensions in mm
----------------	-----------------	-------------	---------	------------------

SMC male header with angled solder pins

Length: 2.9 mm
Colour: Beige
Packaging: Carton

6	09 19 506	└ 323
10	09 19 510	└ 323
14	09 19 514	└ 323
16	09 19 516	└ 323
20	09 19 520	└ 323
26	09 19 526	└ 323
30	09 19 530	└ 323
34	09 19 534	└ 323
40	09 19 540	└ 323
50	09 19 550	└ 323
60	09 19 560	└ 323
64	09 19 564	└ 323

No. of contacts	A	B	E
6	15.2	12.78	2.54 x 2 = 5.08
10	20.3	17.86	2.54 x 4 = 10.16
14	25.4	22.94	2.54 x 6 = 15.24
16	27.9	25.48	2.54 x 7 = 17.78
20	33.0	30.56	2.54 x 9 = 22.86
26	40.6	38.18	2.54 x 12 = 30.48
30	45.72	43.26	2.54 x 14 = 35.56
34	50.8	48.34	2.54 x 16 = 40.64
40	58.4	55.96	2.54 x 19 = 48.26
50	71.3	68.66	2.54 x 24 = 60.96
60	84.0	81.36	2.54 x 29 = 73.66
64	89.1	86.44	2.54 x 31 = 78.74

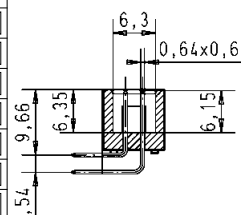

Solder pins for 1 ± 0.1 mm dia. hole

Colour: Beige
Packaging: Tape & Reel

6	09 19 506	└ 323 740
10	09 19 510	└ 323 740
14	09 19 514	└ 323 740
16	09 19 516	└ 323 740
20	09 19 520	└ 323 740
26	09 19 526	└ 323 740
30	09 19 530	└ 323 740
34	09 19 534	└ 323 740
40	09 19 540	└ 323 740

Vacuum plate for pick & place process

Colour: Black
Packaging: Tape & Reel

6	09 19 506	└ 323 741
10	09 19 510	└ 323 741
14	09 19 514	└ 323 741
16	09 19 516	└ 323 741
20	09 19 520	└ 323 741
26	09 19 526	└ 323 741
30	09 19 530	└ 323 741
34	09 19 534	└ 323 741
40	09 19 540	└ 323 741

Vacuum plate for pick & place process

For performance level 3 please specify digit 7
For performance level 2 please specify digit 6
S4 = 0.76 µm (30 µinch) Au or PdNi equivalent



Marking No. 1 contact

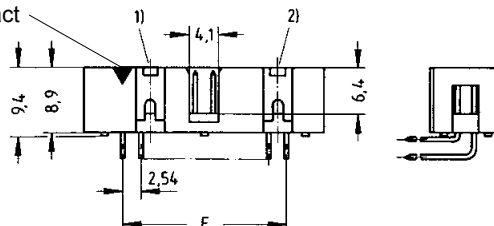

No. 2 contact

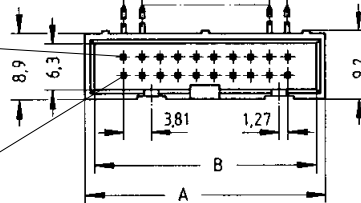

No. 1 contact

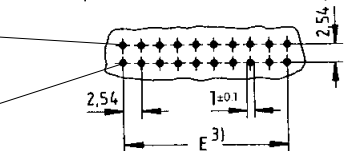

No. 2 contact

No. 1 contact

Identification	Part number	Drawing	Dimensions in mm
----------------	-------------	---------	------------------

Locking lever for female connector with strain relief in conjunction with low-profile male header

09 18 000 9905⁴⁾

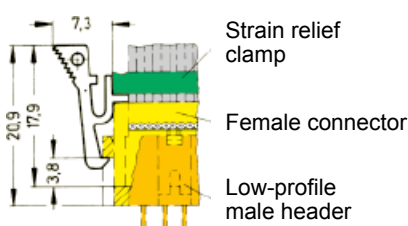

When the security of latching is required and space is a premium, these locking levers can be fitted onto the strain relief of the HARTING female connector.

* Not normally kept in stock

¹⁾ No polarization slot for 6, 10 or 14 way male header
²⁾ No polarization slot for 6 way male header

³⁾ Pitch tolerance: ± 0.1
⁴⁾ Order 2 per female connector

Number of contacts

6-64



Tape & Reel packaging

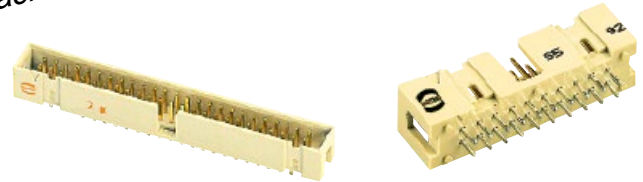

SMC low-profile male header, straight solder pins

Identification	No. of contacts	Part number	Drawing	Dimensions in mm
----------------	-----------------	-------------	---------	------------------

SMC male header with straight solder pins

Length: 2.9 mm
Colour: Beige
Packaging: Carton

6	09 19 506	324
10	09 19 510	324
14	09 19 514	324
16	09 19 516	324
20	09 19 520	324
26	09 19 526	324
30	09 19 530	324
34	09 19 534	324
40	09 19 540	324
50	09 19 550	324
60	09 19 560	324
64	09 19 564	324

No. of contacts	A	B	E
6	15.2	12.78	2.54 x 2 = 5.08
10	20.3	17.86	2.54 x 4 = 10.16
14	25.4	22.94	2.54 x 6 = 15.24
16	27.9	25.48	2.54 x 7 = 17.78
20	33.0	30.56	2.54 x 9 = 22.86
26	40.6	38.18	2.54 x 12 = 30.48
30	45.72	43.26	2.54 x 14 = 35.56
34	50.8	48.34	2.54 x 16 = 40.64
40	58.4	55.96	2.54 x 19 = 48.26
50	71.3	68.66	2.54 x 24 = 60.96
60	84.0	81.36	2.54 x 29 = 73.66
64	89.1	86.44	2.54 x 31 = 78.74

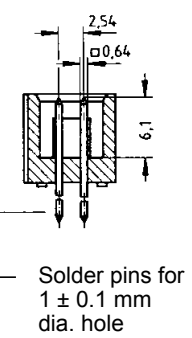

Colour: Beige
Packaging: Tape & Reel

6	09 19 506	324 740
10	09 19 510	324 740
14	09 19 514	324 740
16	09 19 516	324 740
20	09 19 520	324 740
26	09 19 526	324 740
30	09 19 530	324 740
34	09 19 534	324 740
40	09 19 540	324 740

Colour: Black
Packaging: Tape & Reel

6	09 19 506	324 741
10	09 19 510	324 741
14	09 19 514	324 741
16	09 19 516	324 741
20	09 19 520	324 741
26	09 19 526	324 741
30	09 19 530	324 741
34	09 19 534	324 741
40	09 19 540	324 741

For performance level 3 please specify digit 7
For performance level 2 please specify digit 6
S4 = 0.76 µm (30 µinch) Au or PdNi equivalent



Marking No. 1 contact

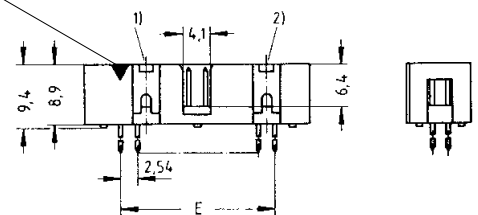

No. 2 contact

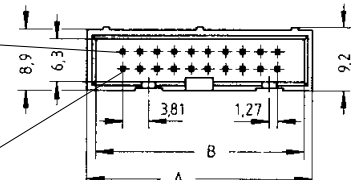

No. 1 contact

No. 2 contact

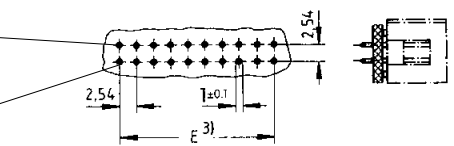

No. 1 contact

Identification	Part number	Drawing	Dimensions in mm
----------------	-------------	---------	------------------

Locking lever for female connector with strain relief in conjunction with low-profile male header

09 18 000 99054)

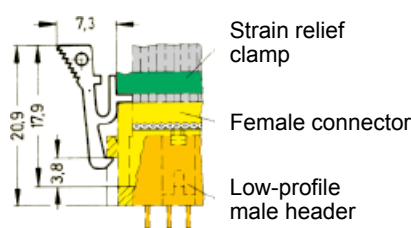

When the security of latching is required and space is a premium, these locking levers can be fitted onto the strain relief of the HARTING female connector.

* Not normally kept in stock

1) No polarization slot for 6, 10 or 14 way male header
2) No polarization slot for 6 way male header

3) Pitch tolerance: ± 0.1
4) Order 2 per female connector

SEK

Accessories

Identification	Part number	Drawing	Dimensions in mm
----------------	-------------	---------	------------------

<p>Polarization key</p> <p>1) Part number comprises 2 keys</p>	<p>09 18 500 9902¹⁾</p>		
---	------------------------------------	--	--

<p>Locking lever (snaps into place, can be fitted whenever required)</p> <p>2) Order 2 per male header</p>	<p>Long: 09 19 000 9903²⁾</p> <p>Short: 09 19 000 9904²⁾</p>	<p>Long</p> <p>Short</p> <p>For use with female connector <u>with</u> strain relief clamp</p> <p>For use with female connector <u>without</u> strain relief clamp</p>	
---	--	---	--

<p>Fixing screws for 1.6 mm P.C. board</p> <p>3) Part number comprises 50 pieces</p>	<p>09 18 000 9906³⁾</p>	<p>BZ 2.9x6.5 (DIN 7981 or DIN 7049)</p> <p>For connectors with part numbers 09 18 5xx x9xx: screwing torque 0.2 Nm 09 19 5xx x9xx: screwing torque 0.4 – 0.5 Nm</p> <p>Screw material: Steel (Inox A2)</p> <p>Plating: Nickel</p>	
---	------------------------------------	--	--

<p>Coding system with loss of contact</p> <p>4) Part number comprises 6 code pins</p>	<p>Code pin 09 18 000 9901⁴⁾</p> <p>Removal tool for male contacts 09 99 000 0133</p>	<p>To avoid cross-plugging adjacent connectors a coding system is required. A code pin is inserted into the appropriate cavity in the female connector. The corresponding male contact is removed by a special removal tool.</p>	
--	--	--	--

SEK

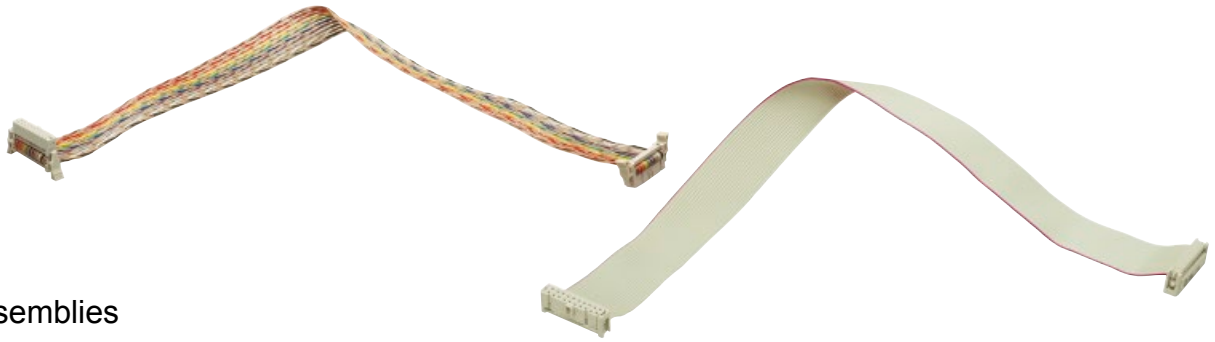

Cable assemblies

Identification	Part number	Drawing	Dimensions in mm
<p>Cable assembly SEK 20-pole Cable: Flat cable, 10 twisted pairs, AWG 28/7, 1.27 mm pitch Wiring: 1:1</p> <p>Length: L = 0.5 m L = 1.0 m L = 1.5 m</p>	<p>33 18 243 0500 060 33 18 243 1000 062 33 18 243 1500 068</p>		
<p>Cable assembly SEK 40-pole Cable: Flat cable, 20 twisted pairs, AWG 28/7, 1.27 mm pitch Wiring: 1:1</p> <p>Length: L = 0.5 m L = 1.0 m L = 1.5 m</p>	<p>33 18 243 0500 055 33 18 243 1000 057 33 18 243 1500 069</p>		
<p>Cable assembly SEK 10-pole Cable: Flat cable, grey, 10 wires, AWG 28/7, 1.27 mm pitch Wiring: 1:1</p> <p>Length: L = 0.1 m L = 0.2 m L = 0.5 m L = 0.8 m L = 1.0 m</p>	<p>33 18 243 0100 063 33 18 243 0200 064 33 18 243 0500 065 33 18 243 0800 066 33 18 243 1000 067</p>		

SEK

Cables for insulation displacement termination

Identification	No. of contacts	Part number	Drawing	Dimensions in mm			
Flat cable grey UL AWM-style 2651 CSA	6	09 18 006 700 □	<p>Conductor material _____ Copper tinned Gauge _____ AWG 28/7 0.089 mm² Voltage rating _____ 300 V_{r.m.s.} Current rating at 25 °C _____ 2.1 A max. Capacity unbalanced _____ 45.9 pF/m Impedance unbalanced _____ 105 Ω Propagation delay _____ 4.9 ns/m nominal Insulation material _____ PVC Temperature rating (operating) _____ -20 °C ... +105 °C Temperature rating (static) _____ -30 °C ... +105 °C Flammability rating _____ UL: VW-1 Insulation resistance _____ > 100 MΩ/km</p>				
	9	09 18 009 700 □					
	10	09 18 010 700 □					
	14	09 18 014 700 □					
	15	09 18 015 700 □					
	16	09 18 016 700 □					
	18	09 18 018 700 □					
	20	09 18 020 700 □					
	24	09 18 024 700 □					
	25	09 18 025 700 □					
	26	09 18 026 700 □					
	28	09 18 028 700 □					
	30	09 18 030 700 □					
	34	09 18 034 700 □					
	37	09 18 037 700 □					
	40	09 18 040 700 □					
	50	09 18 050 700 □					
	60	09 18 060 700 □					
	64	09 18 064 700 □					
	Length per reel						
30.48 m (100 feet)	1						
100 m (328 feet)	4						
Flat cable grey non-halogenated UL style 21447 for VW-1	6	09 18 006 700 □ 900	<p>Conductor material _____ Copper tinned Gauge _____ AWG 28/7 0.089 mm² Voltage rating _____ 300 V_{r.m.s.} Current rating _____ 1.3 A Capacity unbalanced _____ 42.6 pF/m at 1 MHz Impedance unbalanced _____ 100 Ω Inductance _____ 0.56 μH/m Propagation delay _____ 4.8 ns/m Insulation material _____ Non-halogenated flame retardent Polyolefin Temperature rating _____ -40 °C ... +80 °C Insulation resistance _____ 10000 MΩ/km</p>				
	9	09 18 009 700 □ 900					
	10	09 18 010 700 □ 900					
	14	09 18 014 700 □ 900					
	15	09 18 015 700 □ 900					
	16	09 18 016 700 □ 900					
	18	09 18 018 700 □ 900					
	20	09 18 020 700 □ 900					
	24	09 18 024 700 □ 900					
	25	09 18 025 700 □ 900					
	26	09 18 026 700 □ 900					
	28	09 18 028 700 □ 900					
	34	09 18 034 700 □ 900					
	37	09 18 037 700 □ 900					
	40	09 18 040 700 □ 900					
	50	09 18 050 700 □ 900					
	60	09 18 060 700 □ 900					
	64	09 18 064 700 □ 900					
	Length per reel						
	30.48 m (100 feet)	1					

SEK

Cables for insulation displacement termination

Identification	No. of contacts	Part number	Drawing	Dimensions in mm
Flat cable colour coded Length per reel 30.48 m (100 feet) UL AWM-style 2651	6 9 10 14 15 16 18 20 24 25 26 28 30 34 37 40 50 60 64	09 18 006 7005 09 18 009 7005 09 18 010 7005 09 18 014 7005 09 18 015 7005 09 18 016 7005 09 18 018 7005 09 18 020 7005 09 18 024 7005 09 18 025 7005 09 18 026 7005 09 18 028 7005 09 18 030 7005 09 18 034 7005 09 18 037 7005 09 18 040 7005 09 18 050 7005 09 18 060 7005 09 18 064 7005	<p>AWG 28/7 colour coded $1,27 \pm 0,05$ 0,5 $(n - 1) \times 1,27$ 1,00</p>	Colour code sequence (in 10 steps) brown, red, orange, yellow, green, blue, violet, grey, white, black
Flat cable twisted pair Length per reel 30.48 m (100 feet) UL AWM-style 20 130	10 14 16 20 26 34 40 50 60 64	09 18 010 7006 09 18 014 7006 09 18 016 7006 09 18 020 7006 09 18 026 7006 09 18 034 7006 09 18 040 7006 09 18 050 7006 09 18 060 7006 09 18 064 7006	<p>colour coded AWG 28/7 $1,27 \pm 0,13$ 1,02 ± 0,13 $(n - 1) \times 1,27$ 1,07</p> <p>457,2 50,8 508</p>	
		Conductor material _____ Copper tinned Gauge _____ AWG 28/7 0.09 mm ² Voltage rating _____ 300 V _{r.m.s.} Current rating at 25 °C _____ 2.1 A max. Conductor resistance _____ 221 mΩ/m Capacity unbalanced _____ 42.7 pF/m Impedance unbalanced _____ 105 Ω Inductance unbalanced _____ 0.68 μH/m Signal delay _____ 4.9 ns/m Insulation material _____ PVC Temperature rating (operating) _____ -20 °C ... +105 °C Temperature rating (static) _____ -30 °C ... +105 °C Flammability rating _____ UL: VW 1 Insulation resistance _____ 100 MΩ/km		
		Conductor material _____ Copper tinned Gauge _____ AWG 28/7 0.089 mm ² Voltage rating _____ 300 V _{r.m.s.} Conductor resistance _____ 221 mΩ/m Capacity unbalanced _____ 49 pF/m Impedance unbalanced _____ 105 Ω Signal delay _____ 5.2 ns/m Insulation material _____ PVC Temperature rating _____ -20 °C ... +105 °C Flammability rating _____ UL: VW 1 Insulation resistance _____ 10 ⁴ MΩ/km		

SEK

Important: always store reel vertically

Cables for insulation displacement termination

Identification	No. of contacts	Part number	Drawing	Dimensions in mm
----------------	-----------------	-------------	---------	------------------

Round flat cable

with screening (shielding) UL listed PLCC CL2 CSA certified AWM FT-1	9	09 18 009 70	<p>① Flat cable, AWG 28/7 ② Aluminium / Polyester tape (spiral wrap) ③ 85 % minimum coverage tinned copper braid ④ Outer jacket: black PVC</p>	∅ max.	6.86
	10	09 18 010 70		6.86	
	14	09 18 014 70		7.37	
	15	09 18 015 70		7.62	
	16	09 18 016 70		7.87	
	20	09 18 020 70		8.38	
	25	09 18 025 70		9.14	
	26	09 18 026 70		9.14	
	34	09 18 034 70		10.16	
	37	09 18 037 70		10.41	
	40	09 18 040 70		10.92	
	50	09 18 050 70		12.19	
	60	09 18 060 70		13.21	
	64	09 18 064 70		13.46	

Length per reel

30.48 m (100 feet) 07

100 m (328 feet) 10¹⁾

without screening (shielding) UL listed PLCC CL2 CSA certified AWM FT-1	9	09 18 009 7008	<p>① Flat cable, AWG 28/7 ② Clear polyester ③ Outer jacket: black PVC</p>	∅ max.	6.35
	10	09 18 010 7008		6.35	
	14	09 18 014 7008		6.60	
	15	09 18 015 7008		6.86	
	16	09 18 016 7008		7.11	
	20	09 18 020 7008		7.62	
	25	09 18 025 7008		8.38	
	26	09 18 026 7008		8.38	
	34	09 18 034 7008		9.40	
	37	09 18 037 7008		9.65	
	40	09 18 040 7008		10.16	
	50	09 18 050 7008		11.43	
	60	09 18 060 7008		12.45	
	64	09 18 064 7008		12.70	

Length per reel
30.48 m (100 feet)

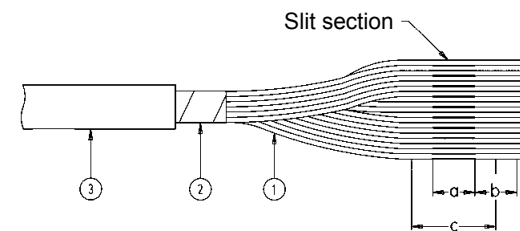

- ① Flat cable, AWG 28/7
- ② Clear polyester
- ③ Outer jacket: black PVC

No. of contacts	a	b	c
9 to 26	19.05	19.05	38.10
34 to 64	38.10	19.05	57.15

Conductor material	Copper tinned
Gauge	AWG 28/7 0.089 mm ²
Voltage rating	300 V _{r.m.s.}
Conductor resistance	225 mΩ/m
Capacity unbalanced	78.7 pF/m
Impedance unbalanced	75 Ω
Signal delay	5.25 ns/m nom.
Insulation material	PVC
Temperature rating	-20 °C ... +105 °C
Flammability rating	UL: VW 1
Insulation resistance	10 ⁴ MΩ/km

* Not normally kept in stock
¹⁾ Only available for 10, 14, 37, 40 and 64 contacts
 Important: always store reels vertically

