

# IGBT - SMPS II Series N-Channel with Anti-Parallel Stealth Diode 600 V

## FGH50N6S2D

### Description

The FGH50N6S2D is a Low Gate Charge, Low Plateau Voltage SMPS II IGBT combining the fast switching speed of the SMPS IGBTs along with lower gate charge, plateau voltage and avalanche capability (UIS). These LGC devices shorten delay times, and reduce the power requirement of the gate drive. These devices are ideally suited for high voltage switched mode power supply applications where low conduction loss, fast switching times and UIS capability are essential. SMPS II LGC devices have been specially designed for:

- Power Factor Correction (PFC) Circuits
- Full Bridge Topologies
- Half Bridge Topologies
- Push-Pull Circuits
- Uninterruptible Power Supplies
- Zero Voltage and Zero Current Switching Circuits

### Features

- 100 kHz Operation at 390 V, 40 A
- 200 kHz Operation at 390 V, 25 A
- 600 V Switching SOA Capability
- Typical Fall Time                    90 ns at  $T_J = 125^\circ\text{C}$
- Low Gate Charge                    70 nC at  $V_{GE} = 15\text{ V}$
- Low Plateau Voltage                6.5 V Typical
- UIS Rated                                480 mJ
- Low Conduction Loss
- This is a Pb-Free Device



ON Semiconductor®

[www.onsemi.com](http://www.onsemi.com)

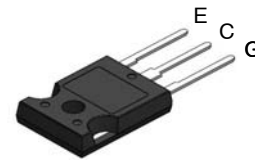
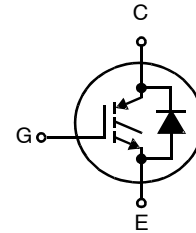

TO-247-3LD  
CASE 340CK

### MARKING DIAGRAM

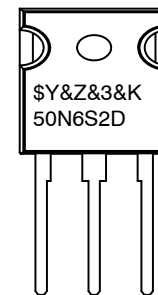

\$Y	= ON Semiconductor Logo
&Z	= Assembly Plant Code
&3	= Numeric Date Code
&K	= Lot Code
50N6S2D	= Specific Device Code

### ORDERING INFORMATION

See detailed ordering and shipping information on page 2 of this data sheet.

# FGH50N6S2D

## MAXIMUM RATINGS (T<sub>C</sub> = 25°C unless otherwise noted)

Parameter	Symbol	Ratings	Unit
Collector to Emitter Breakdown Voltage	BV <sub>CES</sub>	600	V
Collector Current Continuous	I <sub>C</sub>	T <sub>C</sub> = 25°C	75
		T <sub>C</sub> = 110°C	60
Collector Current Pulsed (Note 1)	I <sub>CM</sub>	240	A
Gate to Emitter Voltage Continuous	V <sub>GES</sub>	±20	V
Gate to Emitter Voltage Pulsed	V <sub>GEM</sub>	±30	V
Switching Safe Operating Area at T <sub>J</sub> = 150°C, Figure 2	SSOA	150 A at 600 V	
Pulsed Avalanche Energy, I <sub>CE</sub> = 30 A, L = 1 mH, V <sub>DD</sub> = 50 V	E <sub>AS</sub>	480	mJ
Power Dissipation Total	P <sub>D</sub>	T <sub>C</sub> = 25°C	463
Power Dissipation Derating		T <sub>C</sub> > 25°C	3.7
Operating Junction Temperature Range	T <sub>J</sub>	-55 to +150	°C
Storage Junction Temperature Range	T <sub>STG</sub>	-55 to +150	°C

Stresses exceeding those listed in the Maximum Ratings table may damage the device. If any of these limits are exceeded, device functionality should not be assumed, damage may occur and reliability may be affected.

1. Pulse width limited by maximum junction temperature.

## PACKAGE MARKING AND ORDERING INFORMATION

Device Marking	Device	Package	Tape Width	Quantity
50N6S2D	FGH50N6S2D	TO-247	N/A	30

## THERMAL CHARACTERISTICS

Characteristic	Symbol	Value	Unit
Thermal Resistance Junction-Case, IGBT	R <sub>θJC</sub>	0.27	°C/W
Thermal Resistance Junction-Case, Diode	R <sub>θJC</sub>	1.1	

## ELECTRICAL CHARACTERISTICS (T<sub>C</sub> = 25°C unless otherwise noted)

Parameter	Symbol	Test Conditions	Min	Typ	Max	Unit
-----------	--------	-----------------	-----	-----	-----	------

### OFF STATE CHARACTERISTICS

Collector to Emitter Breakdown Voltage	BV <sub>CES</sub>	I <sub>C</sub> = 250 μA, V <sub>GE</sub> = 0 V,	600	-	-	V
Collector to Emitter Leakage Current	I <sub>CES</sub>	V <sub>CE</sub> = 600 V	T <sub>J</sub> = 25°C	-	-	250
			T <sub>J</sub> = 125°C	-	-	2.8
Gate to Emitter Leakage Current	I <sub>GES</sub>	V <sub>GE</sub> = ±20 V	-	-	±250	nA

### ON STATE CHARACTERISTICS

Collector to Emitter Saturation Voltage	V <sub>CE(SAT)</sub>	I <sub>C</sub> = 30 A, V <sub>GE</sub> = 15 V	T <sub>J</sub> = 25°C	-	1.9	2.7	V
			T <sub>J</sub> = 125°C	-	1.7	2.2	V
Diode Forward Voltage	V <sub>EC</sub>	I <sub>EC</sub> = 30 A	-	2.2	2.6	V	

### DYNAMIC CHARACTERISTICS

Gate Charge	Q <sub>G(ON)</sub>	I <sub>C</sub> = 30 A, V <sub>CE</sub> = 300 V	V <sub>GE</sub> = 15 V	-	70	85	nC
			V <sub>GE</sub> = 20 V	-	90	110	nC
Gate to Emitter Threshold Voltage	V <sub>GE(TH)</sub>	I <sub>C</sub> = 250 μA, V <sub>CE</sub> = V <sub>GE</sub>	3.5	4.3	5.0	V	
Gate to Emitter Plateau Voltage	V <sub>GEP</sub>	I <sub>C</sub> = 30 A, V <sub>CE</sub> = 300 V	-	6.5	8.0	V	

# FGH50N6S2D

## ELECTRICAL CHARACTERISTICS (T<sub>C</sub> = 25°C unless otherwise noted) (continued)

Parameter	Symbol	Test Conditions	Min	Typ	Max	Unit
<b>SWITCHING CHARACTERISTICS</b>						
Switching SOA	SSOA	T <sub>J</sub> = 150°C, R <sub>G</sub> = 3 Ω, V <sub>GE</sub> = 15 V, L = 100 μH, V <sub>CE</sub> = 600 V	150	–	–	A
Current Turn-On Delay Time	t <sub>d(ON)</sub>	IGBT and Diode at T <sub>J</sub> = 25°C, I <sub>CE</sub> = 30 A, V <sub>CE</sub> = 390 V, V <sub>GE</sub> = 15 V, R <sub>G</sub> = 3 Ω, , L = 200 μH, Test Circuit – Figure 26	–	13	–	ns
Current Rise Time	t <sub>rl</sub>		–	15	–	ns
Current Turn-Off Delay Time	t <sub>d(OFF)</sub>		–	55	–	ns
Current Fall Time	t <sub>fl</sub>		–	50	–	ns
Turn-On Energy (Note 2)	E <sub>ON1</sub>		–	260	–	μJ
Turn-On Energy (Note 2)	E <sub>ON2</sub>		–	330	–	μJ
Turn-Off Energy Loss (Note 3)	E <sub>OFF</sub>		–	250	350	μJ
Current Turn-On Delay Time	t <sub>d(ON)</sub>	IGBT and Diode at T <sub>J</sub> = 125°C, I <sub>CE</sub> = 30 A, V <sub>CE</sub> = 390 V, V <sub>GE</sub> = 15 V, R <sub>G</sub> = 3 Ω, , L = 200 μH, Test Circuit – Figure 26	–	13	–	ns
Current Rise Time	t <sub>rl</sub>		–	15	–	ns
Current Turn-Off Delay Time	t <sub>d(OFF)</sub>		–	92	150	ns
Current Fall Time	t <sub>fl</sub>		–	88	100	ns
Turn-On Energy (Note 2)	E <sub>ON1</sub>		–	260	–	μJ
Turn-On Energy (Note 2)	E <sub>ON2</sub>		–	490	600	μJ
Turn-Off Energy Loss (Note 3)	E <sub>OFF</sub>		–	575	850	μJ
Diode Reverse Recovery Time	t <sub>rr</sub>	I <sub>EC</sub> = 30 A, dI <sub>EC</sub> /dt = 200 A/μs	–	50	55	ns
		I <sub>EC</sub> = 1 A, dI <sub>EC</sub> /dt = 200 A/μs	–	30	42	ns

Product parametric performance is indicated in the Electrical Characteristics for the listed test conditions, unless otherwise noted. Product performance may not be indicated by the Electrical Characteristics if operated under different conditions.

- Values for two Turn-On loss conditions are shown for the convenience of the circuit designer. E<sub>ON1</sub> is the turn-on loss of the IGBT only. E<sub>ON2</sub> is the turn-on loss when a typical diode is used in the test circuit and the diode is at the same T<sub>J</sub> as the IGBT. The diode type is specified in Figure 26.
- Turn-Off Energy Loss (E<sub>OFF</sub>) is defined as the integral of the instantaneous power loss starting at the trailing edge of the input pulse and ending at the point where the collector current equals zero (I<sub>CE</sub> = 0A). All devices were tested per JEDEC Standard No. 24-1 Method for Measurement of Power Device Turn-Off Switching Loss. This test method produces the true total Turn-Off Energy Loss.

# FGH50N6S2D

## TYPICAL PERFORMANCE CURVES ( $T_J = 25^\circ\text{C}$ unless otherwise noted)

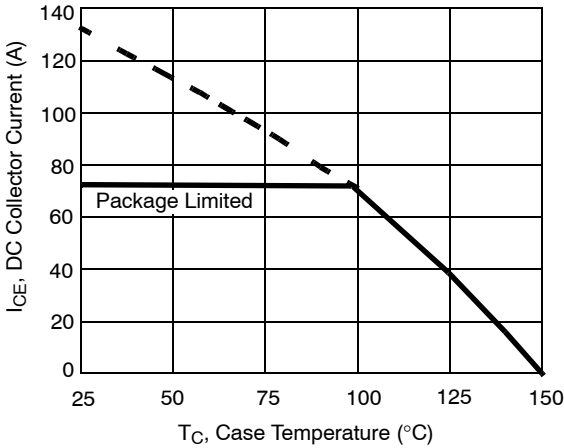

**Figure 1. DC Collector Current vs. Case Temperature**

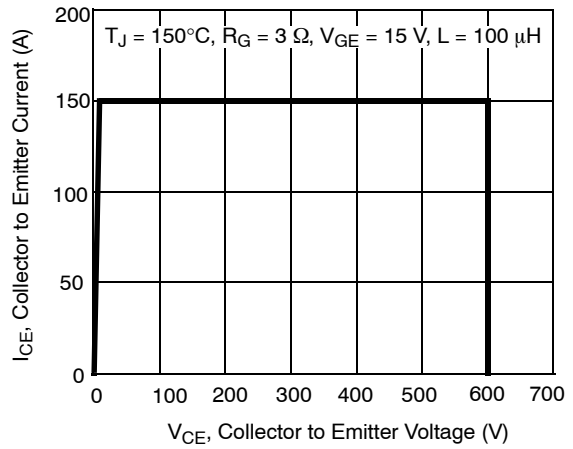

**Figure 2. Minimum Switching Safe Operating Area**

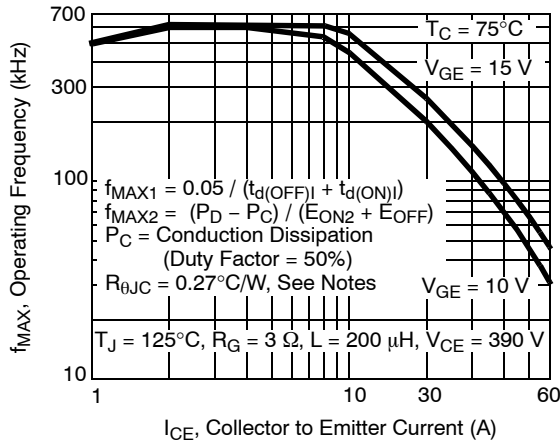

**Figure 3. Operating Frequency vs. Collector to Emitter Current**

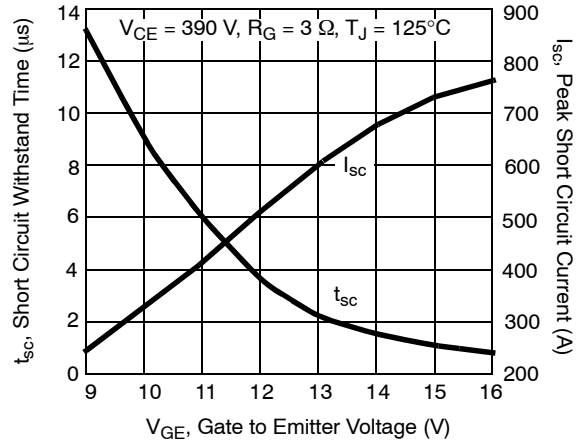

**Figure 4. Short Circuit Withstand Time**

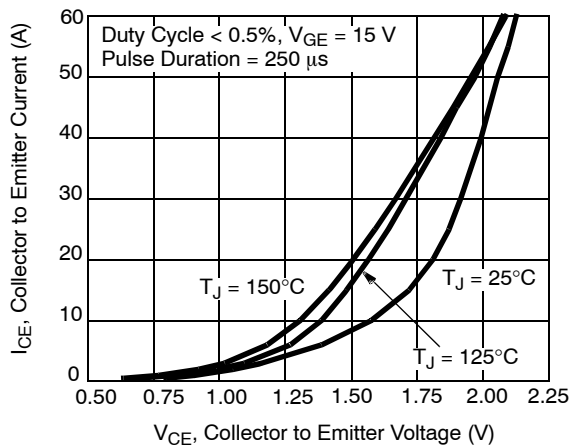

**Figure 5. Collector to Emitter On-State Voltage**

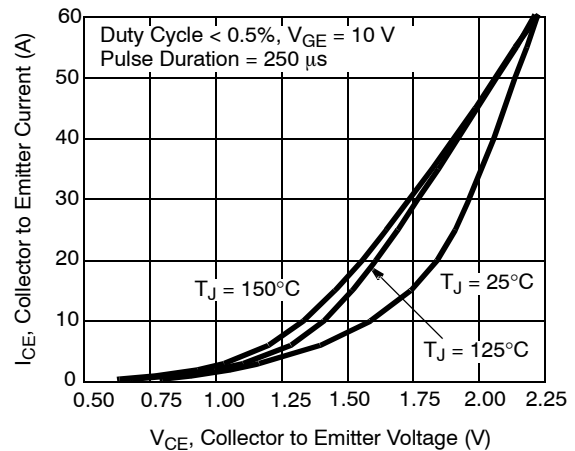

**Figure 6. Collector to Emitter On-State Voltage**

TYPICAL PERFORMANCE CURVES ( $T_J = 25^\circ\text{C}$  unless otherwise noted) (continued)

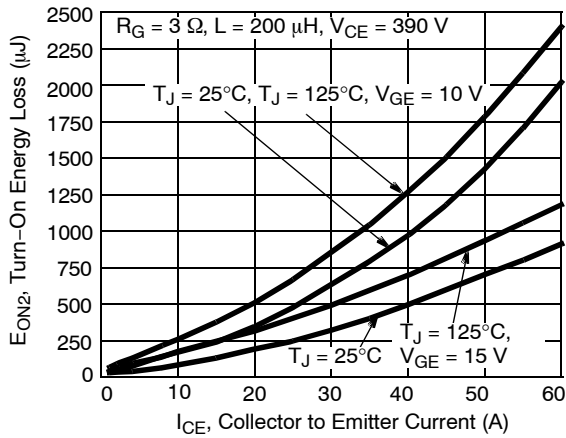

Figure 7. Turn-On Energy Loss vs. Collector to Emitter Current

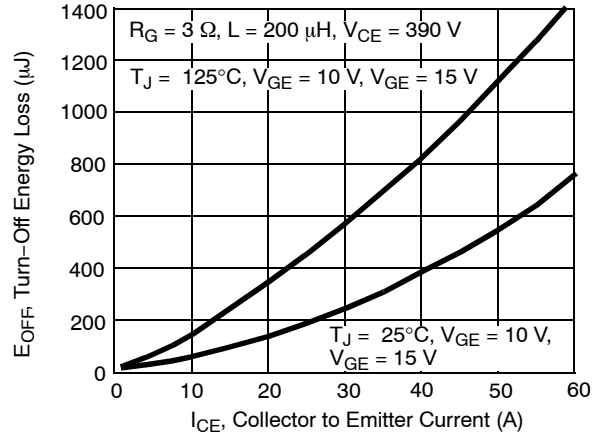

Figure 8. Turn-Off Energy Loss vs. Collector to Emitter Current

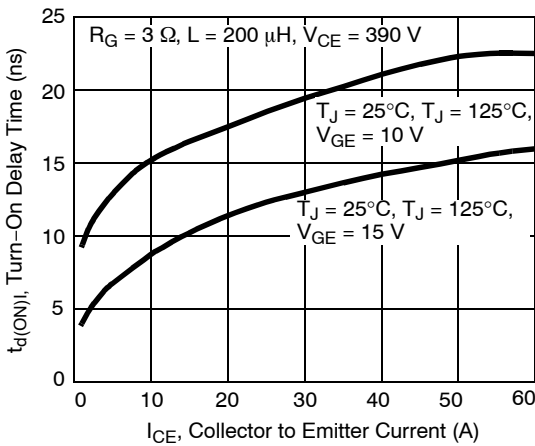

Figure 9. Turn-On Delay Time vs. Collector to Emitter Current

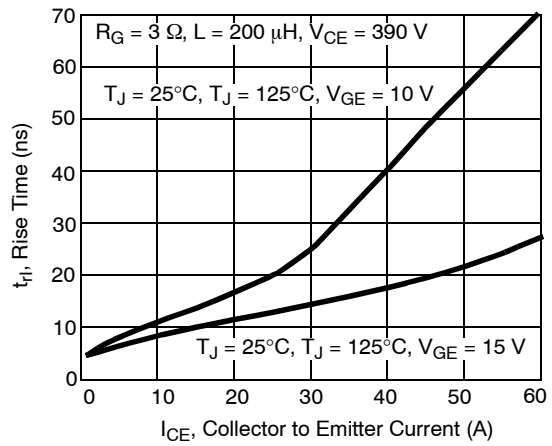

Figure 10. Turn-On Rise Time vs. Collector to Emitter Current

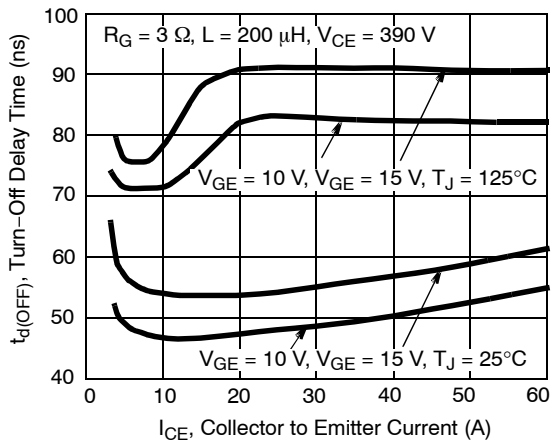

Figure 11. Turn-Off Delay Time vs. Collector to Emitter Current

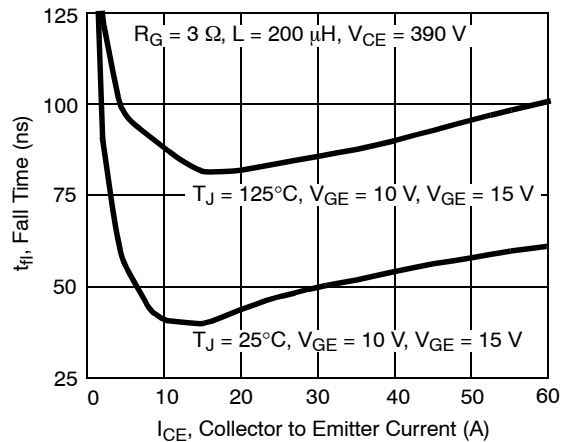

Figure 12. Fall Time vs. Collector to Emitter Current

TYPICAL PERFORMANCE CURVES ( $T_J = 25^\circ\text{C}$  unless otherwise noted) (continued)

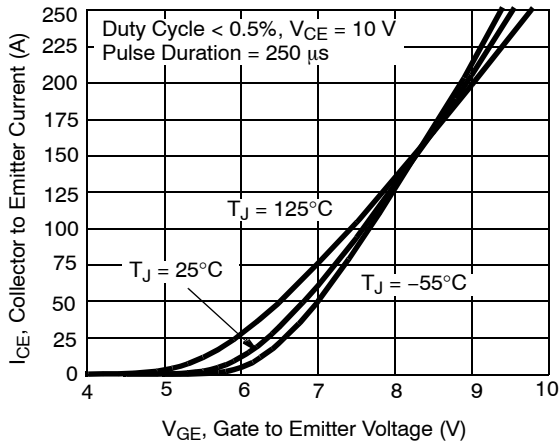

Figure 13. Transfer Characteristics

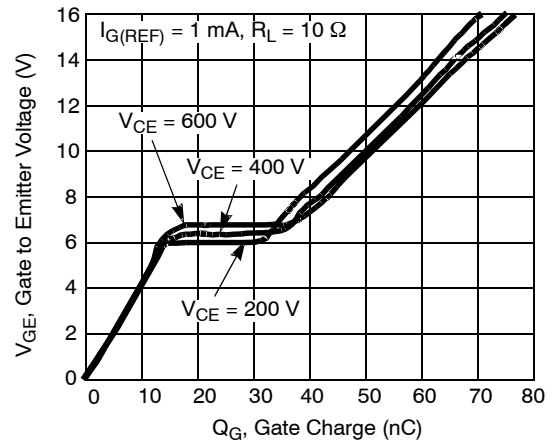

Figure 14. Gate Charge

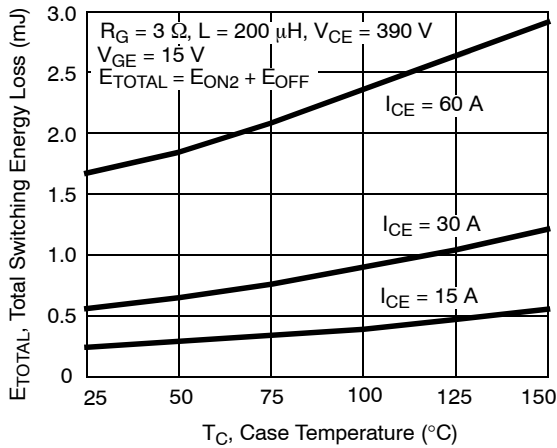

Figure 15. Total Switching Loss vs. Case Temperature

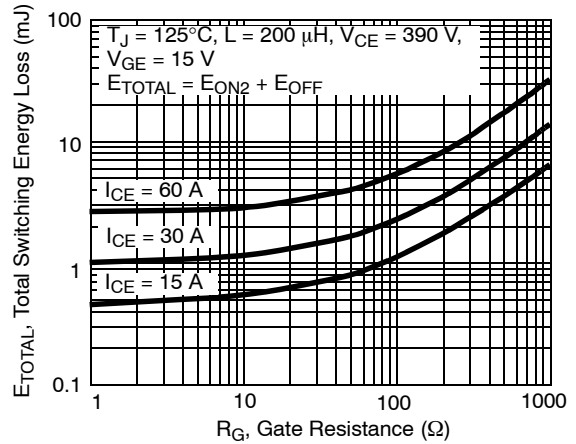

Figure 16. Total Switching Loss vs. Gate Resistance

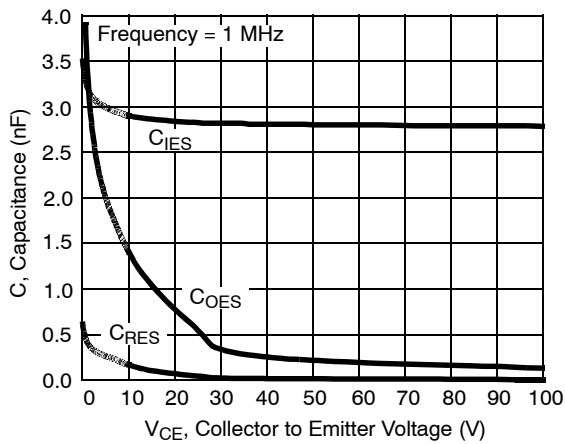

Figure 17. Capacitance vs. Collector to Emitter Voltage

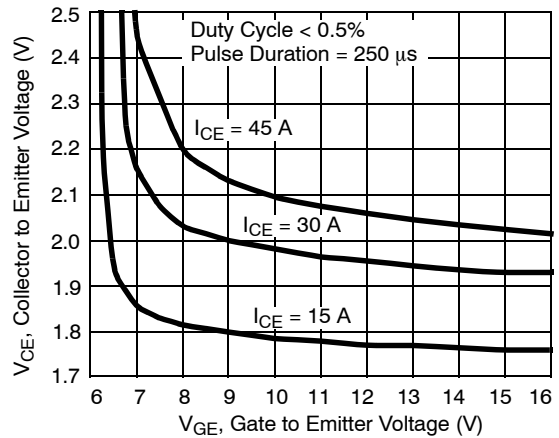
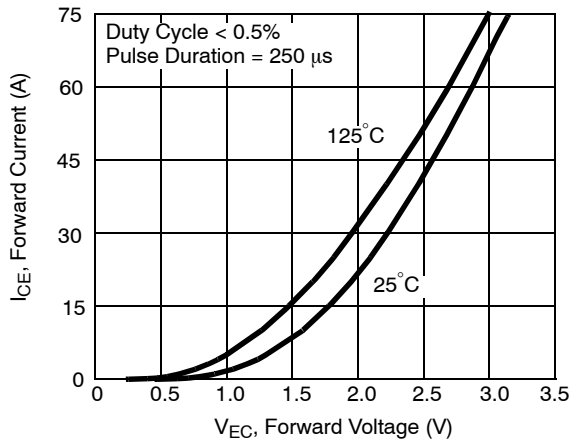

Figure 18. Collector to Emitter On-State Voltage vs. Gate to Emitter Voltage

# FGH50N6S2D

## TYPICAL PERFORMANCE CURVES ( $T_J = 25^\circ\text{C}$ unless otherwise noted) (continued)



**Figure 19. Diode Forward Current vs. Forward Voltage Drop**

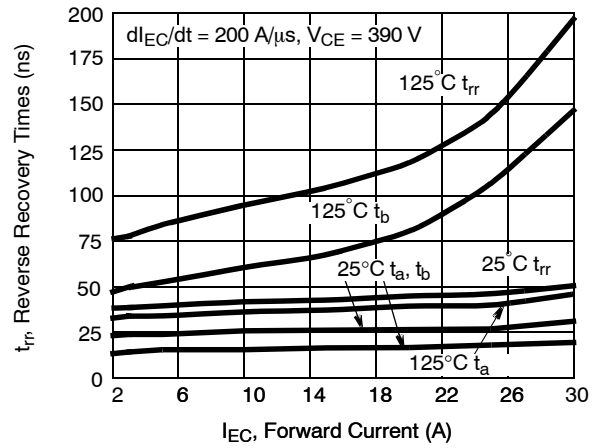

**Figure 20. Recovery Times vs. Forward Current**

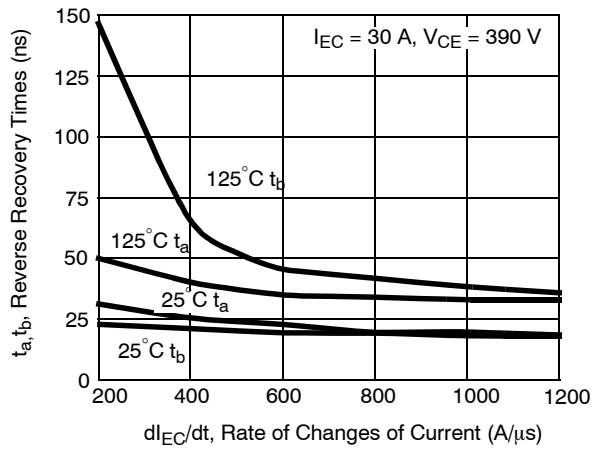

**Figure 21. Recovery Times vs. Rate of Change of Current**

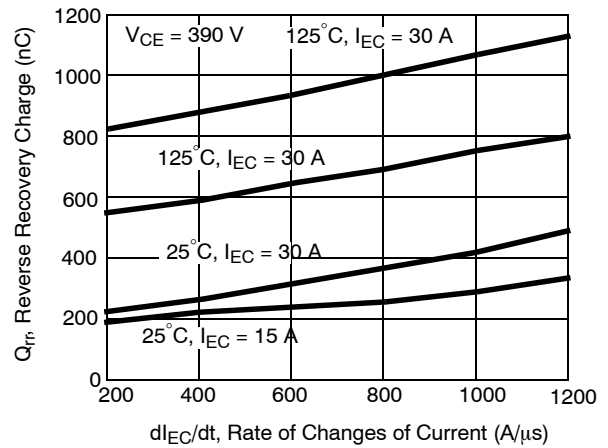

**Figure 22. Stored Charge vs. Rate of Change of Current**

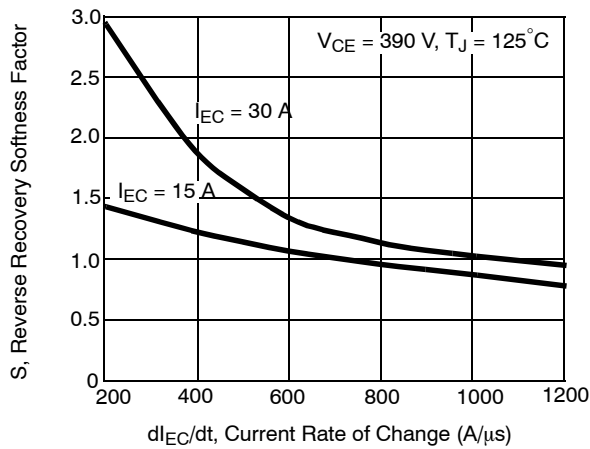

**Figure 23. Reverse Recovery Softness Factor vs. Rate of Change of Current**

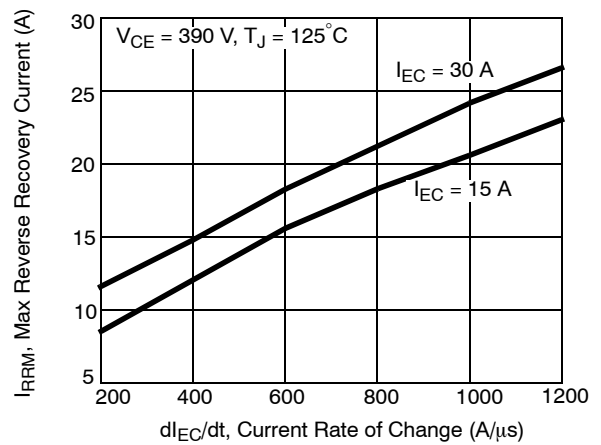

**Figure 24. Maximum Reverse Recovery Current vs. Rate of Change of Current**

# FGH50N6S2D

## TYPICAL PERFORMANCE CURVES ( $T_J = 25^\circ\text{C}$ unless otherwise noted) (continued)

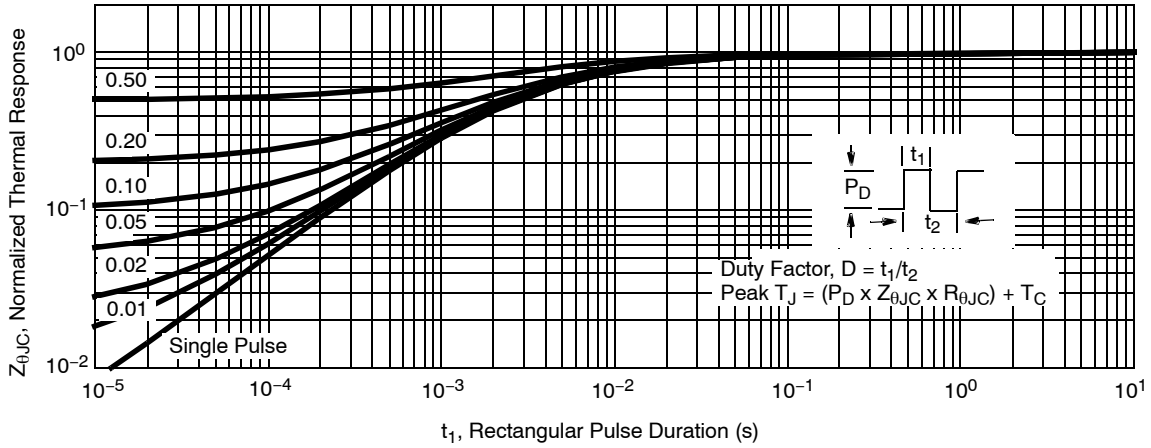

Figure 25. IGBT Normalized Transient Thermal Impedance, Junction to Case

## TEST CIRCUIT AND WAVEFORMS

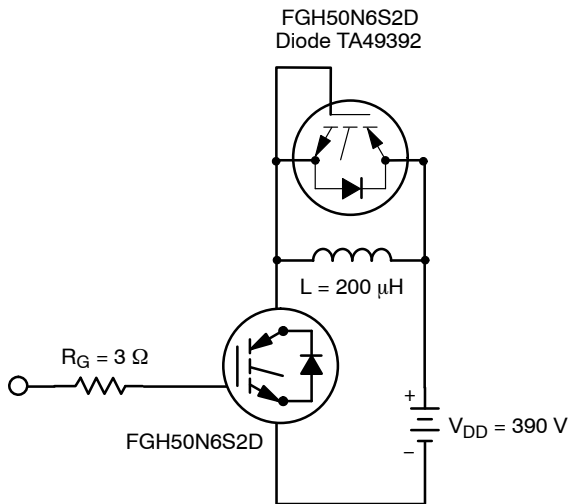

Figure 26. Inductive Switching Test Circuit

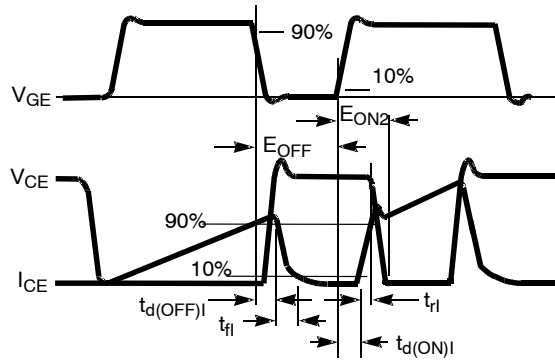

Figure 27. Switching Test Waveforms



## Handling Precautions for IGBTs

Insulated Gate Bipolar Transistors are susceptible to gate–insulation damage by the electrostatic discharge of energy through the devices. When handling these devices, care should be exercised to assure that the static charge built in the handler’s body capacitance is not discharged through the device. With proper handling and application procedures, however, IGBTs are currently being extensively used in production by numerous equipment manufacturers in military, industrial and consumer applications, with virtually no damage problems due to electrostatic discharge. IGBTs can be handled safely if the following basic precautions are taken:

1. Prior to assembly into a circuit, all leads should be kept shorted together either by the use of metal shorting springs or by the insertion into conductive material such as “ECCOSORBD™ LD26” or equivalent.
2. When devices are removed by hand from their carriers, the hand being used should be grounded by any suitable means – for example, with a metallic wristband.
3. Tips of soldering irons should be grounded.
4. Devices should never be inserted into or removed from circuits with power on.
5. **Gate Voltage Rating** – Never exceed the gate–voltage rating of  $V_{GEM}$ . Exceeding the rated  $V_{GE}$  can result in permanent damage to the oxide layer in the gate region.
6. **Gate Termination** – The gates of these devices are essentially capacitors. Circuits that leave the gate open–circuited or floating should be avoided. These conditions can result in turn–on of the device due to voltage buildup on the input capacitor due to leakage currents or pickup.
7. **Gate Protection** – These devices do not have an internal monolithic Zener diode from gate to emitter. If gate protection is required an external Zener is recommended.

## Operating Frequency Information

Operating frequency information for a typical device (Figure 3) is presented as a guide for estimating device performance for a specific application. Other typical frequency vs collector current ( $I_{CE}$ ) plots are possible using the information shown for a typical unit in Figures 5, 6, 7, 8, 9 and 11. The operating frequency plot (Figure 3) of a typical device shows  $f_{MAX1}$  or  $f_{MAX2}$ ; whichever is smaller at each point. The information is based on measurements of a typical device and is bounded by the maximum rated junction temperature.

$f_{MAX1}$  is defined by  $f_{MAX1} = 0.05 / (t_{d(OFF)I} + t_{d(ON)I})$ . Deadtime (the denominator) has been arbitrarily held to 10% of the on–state time for a 50% duty factor. Other definitions are possible.  $t_{d(OFF)I}$  and  $t_{d(ON)I}$  are defined in Figure 27. Device turn–off delay can establish an additional frequency limiting condition for an application other than  $T_{JM}$ .  $t_{d(OFF)I}$  is important when controlling output ripple under a lightly loaded condition.

$f_{MAX2}$  is defined by  $f_{MAX2} = (P_D - P_C) / (E_{OFF} + E_{ON2})$ . The allowable dissipation ( $P_D$ ) is defined by  $P_D = (T_{JM} - T_C) / R_{\theta JC}$ . The sum of device switching and conduction losses must not exceed  $P_D$ . A 50% duty factor was used (Figure 3) and the conduction losses ( $P_C$ ) are approximated by  $P_C = (V_{CE} \times I_{CE}) / 2$ .

$E_{ON2}$  and  $E_{OFF}$  are defined in the switching waveforms shown in Figure 27.  $E_{ON2}$  is the integral of the instantaneous power loss ( $I_{CE} \times V_{CE}$ ) during turn–on and  $E_{OFF}$  is the integral of the instantaneous power loss ( $I_{CE} \times V_{CE}$ ) during turn–off. All tail losses are included in the calculation for  $E_{OFF}$ ; i.e., the collector current equals zero ( $I_{CE} = 0$ )

**TO-247-3LD SHORT LEAD**  
**CASE 340CK**  
**ISSUE A**

DATE 31 JAN 2019

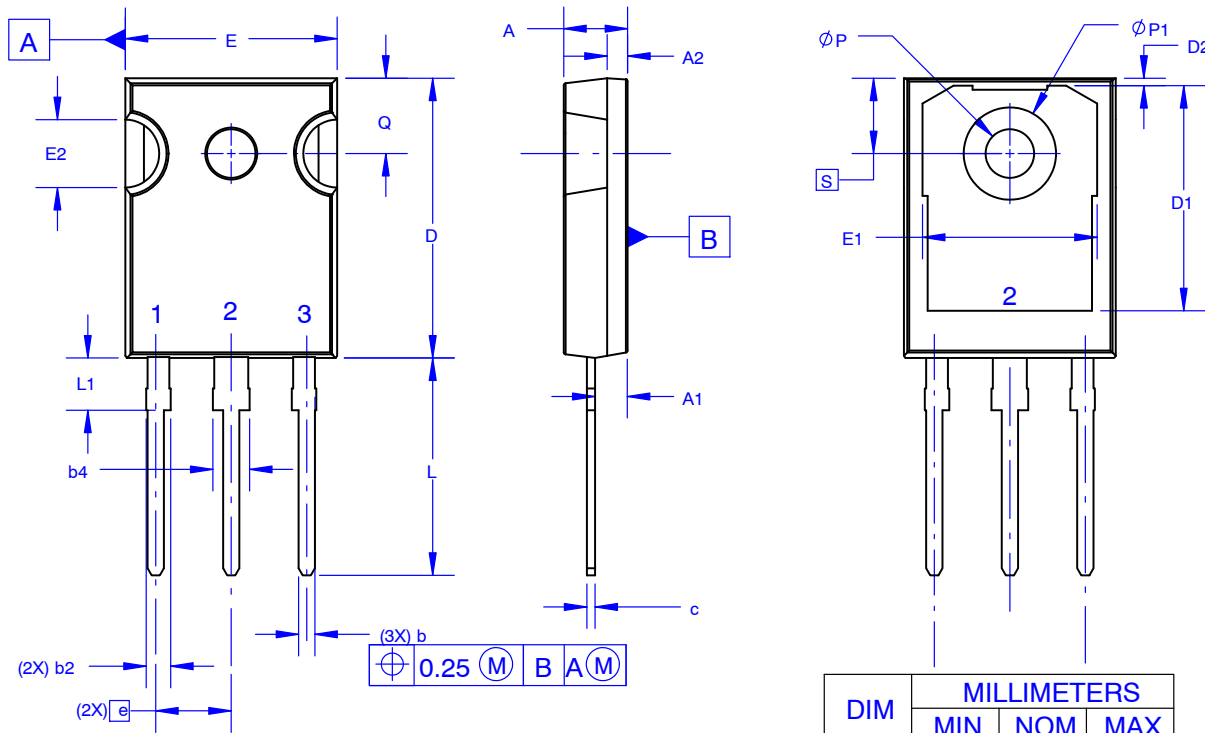

NOTES: UNLESS OTHERWISE SPECIFIED.

- A. DIMENSIONS ARE EXCLUSIVE OF BURRS, MOLD FLASH, AND TIE BAR EXTRUSIONS.
- B. ALL DIMENSIONS ARE IN MILLIMETERS.
- C. DRAWING CONFORMS TO ASME Y14.5 - 2009.
- D. DIMENSION A1 TO BE MEASURED IN THE REGION DEFINED BY L1.
- E. LEAD FINISH IS UNCONTROLLED IN THE REGION DEFINED BY L1.

**GENERIC MARKING DIAGRAM\***

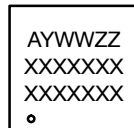

- XXXX = Specific Device Code
- A = Assembly Location
- Y = Year
- WW = Work Week
- ZZ = Assembly Lot Code

\*This information is generic. Please refer to device data sheet for actual part marking. Pb-Free indicator, "G" or microdot "•", may or may not be present. Some products may not follow the Generic Marking.

DIM	MILLIMETERS		
	MIN	NOM	MAX
A	4.58	4.70	4.82
A1	2.20	2.40	2.60
A2	1.40	1.50	1.60
b	1.17	1.26	1.35
b2	1.53	1.65	1.77
b4	2.42	2.54	2.66
c	0.51	0.61	0.71
D	20.32	20.57	20.82
D1	13.08	~	~
D2	0.51	0.93	1.35
E	15.37	15.62	15.87
E1	12.81	~	~
E2	4.96	5.08	5.20
e	~	5.56	~
L	15.75	16.00	16.25
L1	3.69	3.81	3.93
ØP	3.51	3.58	3.65
ØP1	6.60	6.80	7.00
Q	5.34	5.46	5.58
S	5.34	5.46	5.58

<b>DOCUMENT NUMBER:</b>	<b>98AON13851G</b>	Electronic versions are uncontrolled except when accessed directly from the Document Repository. Printed versions are uncontrolled except when stamped "CONTROLLED COPY" in red.
<b>DESCRIPTION:</b>	<b>TO-247-3LD SHORT LEAD</b>	<b>PAGE 1 OF 1</b>

ON Semiconductor and are trademarks of Semiconductor Components Industries, LLC dba ON Semiconductor or its subsidiaries in the United States and/or other countries. ON Semiconductor reserves the right to make changes without further notice to any products herein. ON Semiconductor makes no warranty, representation or guarantee regarding the suitability of its products for any particular purpose, nor does ON Semiconductor assume any liability arising out of the application or use of any product or circuit, and specifically disclaims any and all liability, including without limitation special, consequential or incidental damages. ON Semiconductor does not convey any license under its patent rights nor the rights of others.

**onsemi**, **Onsemi**, and other names, marks, and brands are registered and/or common law trademarks of Semiconductor Components Industries, LLC dba "**onsemi**" or its affiliates and/or subsidiaries in the United States and/or other countries. **onsemi** owns the rights to a number of patents, trademarks, copyrights, trade secrets, and other intellectual property. A listing of **onsemi**'s product/patent coverage may be accessed at [www.onsemi.com/site/pdf/Patent-Marking.pdf](http://www.onsemi.com/site/pdf/Patent-Marking.pdf). **onsemi** reserves the right to make changes at any time to any products or information herein, without notice. The information herein is provided "as-is" and **onsemi** makes no warranty, representation or guarantee regarding the accuracy of the information, product features, availability, functionality, or suitability of its products for any particular purpose, nor does **onsemi** assume any liability arising out of the application or use of any product or circuit, and specifically disclaims any and all liability, including without limitation special, consequential or incidental damages. Buyer is responsible for its products and applications using **onsemi** products, including compliance with all laws, regulations and safety requirements or standards, regardless of any support or applications information provided by **onsemi**. "Typical" parameters which may be provided in **onsemi** data sheets and/or specifications can and do vary in different applications and actual performance may vary over time. All operating parameters, including "Typicals" must be validated for each customer application by customer's technical experts. **onsemi** does not convey any license under any of its intellectual property rights nor the rights of others. **onsemi** products are not designed, intended, or authorized for use as a critical component in life support systems or any FDA Class 3 medical devices or medical devices with a same or similar classification in a foreign jurisdiction or any devices intended for implantation in the human body. Should Buyer purchase or use **onsemi** products for any such unintended or unauthorized application, Buyer shall indemnify and hold **onsemi** and its officers, employees, subsidiaries, affiliates, and distributors harmless against all claims, costs, damages, and expenses, and reasonable attorney fees arising out of, directly or indirectly, any claim of personal injury or death associated with such unintended or unauthorized use, even if such claim alleges that **onsemi** was negligent regarding the design or manufacture of the part. **onsemi** is an Equal Opportunity/Affirmative Action Employer. This literature is subject to all applicable copyright laws and is not for resale in any manner.

## PUBLICATION ORDERING INFORMATION

### LITERATURE FULFILLMENT:

Email Requests to: [orderlit@onsemi.com](mailto:orderlit@onsemi.com)

**onsemi Website:** [www.onsemi.com](http://www.onsemi.com)

### TECHNICAL SUPPORT

**North American Technical Support:**  
Voice Mail: 1 800-282-9855 Toll Free USA/Canada  
Phone: 011 421 33 790 2910

**Europe, Middle East and Africa Technical Support:**

Phone: 00421 33 790 2910

For additional information, please contact your local Sales Representative